

OMNICOMM

Omnicomm 3.1 Terminals

Smart, Light

User Manual

22.06.2021

Contents

5	General Information
5	Attention
6	Technical Specifications
8	Installation
8	SIM Card Inserting
10	Wire Colour Designation
12	Power Supply and Ignition Key
13	Terminal
13	Setting Overview
14	Omnicom Configurator
16	Remote Configuration Server (RCS)
16	Operation Parameters Setting
16	GPRS Connection
17	Connection to Communication Servers for Light
18	Data Collection
19	Data Transmission to a Communication Server
21	Selection of Ignition Source
21	Selection of Speed Source
22	Engine RPM
22	Driving Safety Control
27	Case Tampering Control

27	Internal Battery for Light
28	GPS / GLONASS Signals Jamming Detector for Light
28	GSM Signal Jamming Detector for Light
29	Service Functions
29	Terminal Reboot
29	Setting Password on Configuration Changing
31	Data Collection and Transmission Blocking
31	Remote Configuration Server Operation Setting
32	Terminal SIM Card Number Identification
32	The Set Up and an Update of Built-in Firmware for the Omnicomm LLS 5 and LLS-Ex 5 Fuel Sensors
33	Auxiliary Equipment
33	RS-485 Interface
34	Fuel Level Sensors
38	Omnicomm ICON Display
39	Omnicomm LLD Indicator
40	CAN-LOG controllers for Light
43	Universal Inputs
47	Driver Identification
48	Controlled equipment for Light
51	Geofence Setting for Light
52	Panic button
53	CAN Bus
56	LED Notification

- 57 **SMS Commands**
- 63 **SMS from the Terminal**
- 64 **Firmware Change Log**

General Information

Omnicom 3.1 Terminals

Smart, Light

General Information

Omnicom terminals – vehicle equipment designed to gather information on the vehicle parameters and transmit data to Omnicomm Online or a third-party fleet monitoring system.

Main functions:

- Determination of location, speed and movement direction of the vehicle
- Reading and filtering values from fuel level sensors and a wide range of connected equipment
- Remote control of connected auxiliary equipment
- Data storage in non-volatile memory
- Data transmission to Omnicomm Online and other fleet monitoring systems

Models of Omnicomm terminal differ from each other in the design and range of connected equipment.

Attention

While carrying out installation, observe the safety rules and regulatory requirements for this type of work.

Technical Specifications

Technical Specifications

	Omnicom Smart	Omnicom Light
Communication		
Satellite Navigation Systems	GLONASS/GPS	GLONASS/GPS
Data transmission channel	GPRS	GPRS
Number of SIM cards	1	1
Power source		
Power supply voltage, V	8...30	8...30
Overvoltage protection	Yes	Yes
Backup battery capacity, mAh	-	650
External sensor power supply	No	No
Data collection and transmission		
Data collection period, s	15...240	15...240
Non-volatile memory capacity, events	150 000	150 000
Inputs and outputs		
Ignition key input	Yes	Yes

Technical Specifications

	Omnicom Smart	Omnicom Light
Communication		
RPM sensor input	Yes	Yes
Number of universal inputs	1	2
Number of digital outputs	-	1
Interfaces		
CAN interface	Yes	Yes
RS-485 interface	1	1
USB interface	Yes	Yes
Built-in accelerometer	Yes	Yes
Design		
Dimensions, mm	67,0 x 67,0 x 22,0	67,0 x 67,0 x 22,0
Working temperature range, C (without the internal battery)	- 40...+85	- 40...+85
Body tampering sensor	Yes	Yes
Antenna design	Built-in	Built-in
Capabilities		

Installation

	Omnicom Smart	Omnicom Light
Communication		
Fuel level sensors connection	2	4
Remote control through GPRS	Yes	Yes
Data output via external indicator	Yes	Yes
SMS notifications	Yes	Yes

Installation

SIM Card Inserting

Before SIM card inserting disable PIN request at activation. To this end insert the card in any cell phone and disable PIN request, according to the cell phone operating instruction.

1. Push the terminal seal back
2. Insert the SIM card into the connector until it clicks
3. Return the seal to its original position

Installation

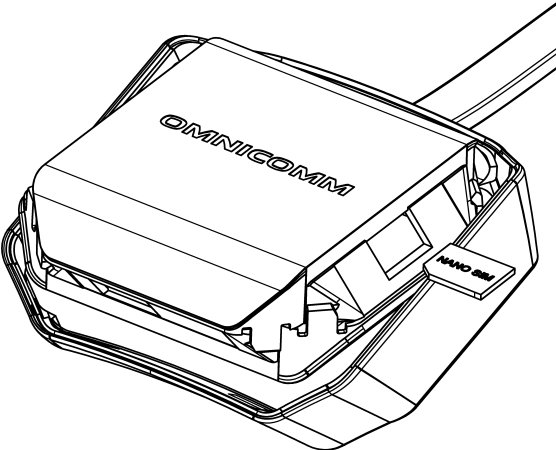

Installation

Wire Colour Designation

Omnicom Smart terminal

Name of signal	Designation	Wire colour in cable
Ground (negative) for power supply	Ground (power)	Black
RPM input	Tachometer	Yellow
Not used	NC	Green
Not used	NC	White
Line B RS-485	B RS-485	Brown
Line A RS-485	A RS-485	Pink
Vehicle power supply voltage	Power	Red
Ignition key	IGN	Purple
Universal input 1	Input 1	Blue
Not used	NC	Grey
CAN H	CAN H	Orange
CAN L	CAN L	Yellow-green

Installation

Omnicom Light terminal

Name of signal	Designation	Wire colour in cable
Ground (negative) for power supply	Ground (power)	Black
RPM input	Tachometer	Yellow
Controlled output 1	Output 1	Green
Not used	NC	White
Line B RS-485	B RS-485	Brown
Line A RS-485	A RS-485	Pink
Vehicle power supply voltage	Power	Red
Ignition key	IGN	Purple
Universal input 1	Input 1	Blue
Universal input 2	Input 2	Grey
CAN H	CAN H	Orange
CAN L	CAN L	Yellow-green

Installation

Power Supply and Ignition Key

Connect Omnicomm Smart and Light terminals as per diagrams without the ground disconnect switch:

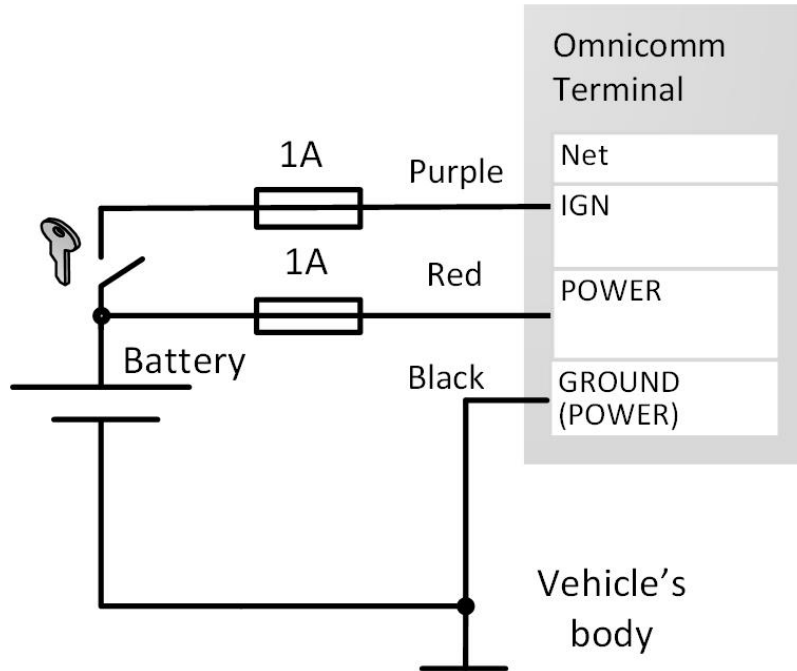

before ground disconnect switch:

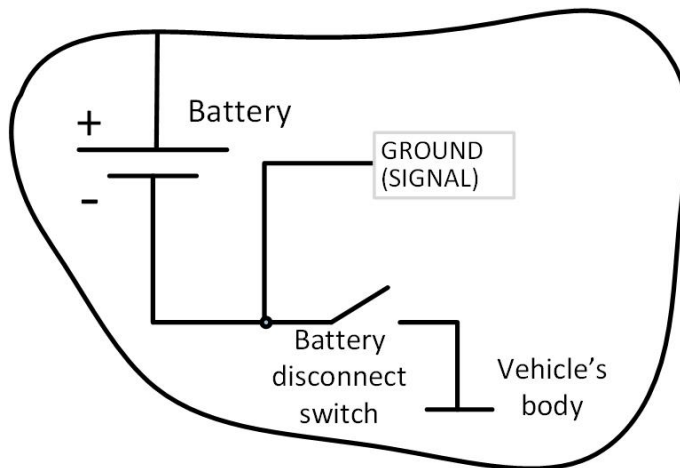

Setting Overview

after ground disconnect switch:

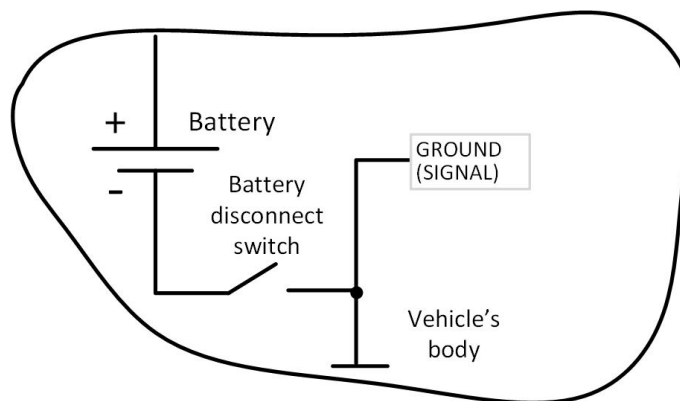

Terminal

The terminal shall be installed inside the vehicle cabin on a flat surface or using a mounting plate.

GPS/GLONASS and GSM antennas are provided in the terminal, follow the recommendations for terminal's positioning:

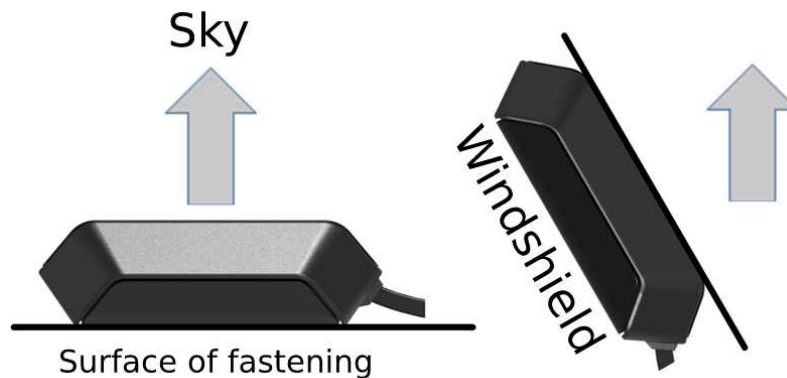

We recommend to install it on the windshield or on the horizontal surface of the instrument panel in a place providing a good radio pick-up range of the sky.

Fasten the terminal to the surface with a double-sided adhesive tape.

When using a mounting plate, fix it on the surface with self-tapping screws. Fasten the terminal to the plate with a double-sided adhesive tape.

Setting Overview

Setting Overview

Omnicom terminals may be configured in two ways:

1. In the Omnicomm Configurator when the terminal is connected to a PC
2. In the Remote Configuration Server (RCS) – remotely

Initial terminal setting shall be carried out in Omnicomm Configurator.

Omnicom Configurator

1. Connection the terminal to a PC using USB cable
2. Install and run Omnicomm Configurator. A window will open

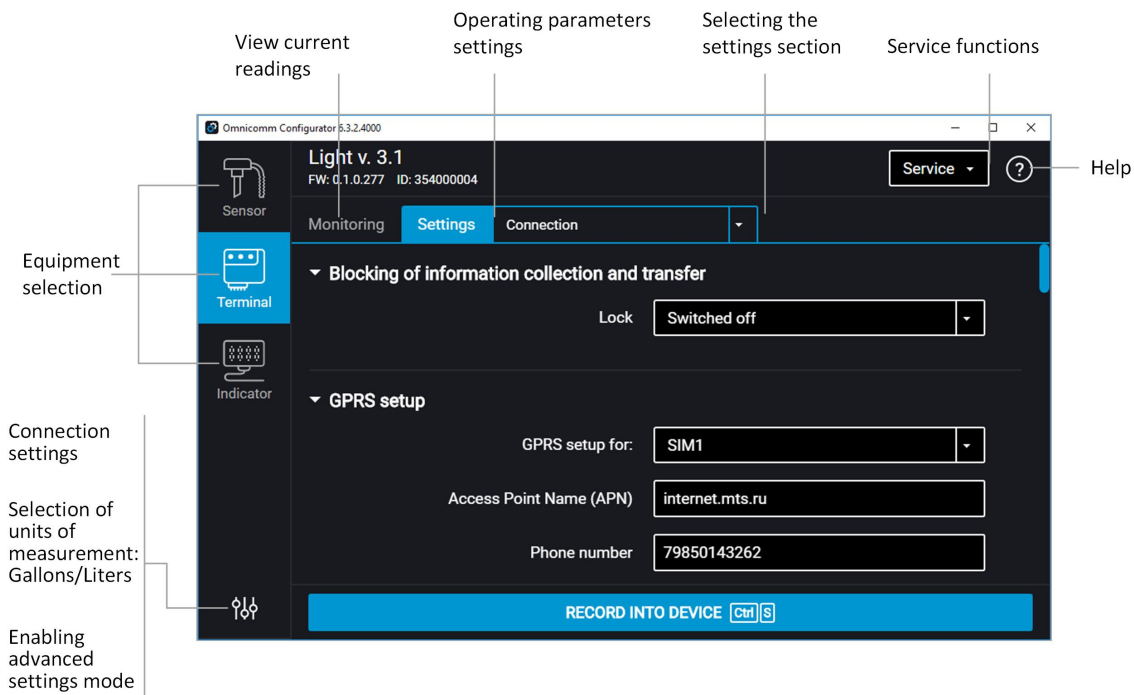

3. Select equipment – “Terminal”.

Advanced mode allows you to configure all the equipment parameters available.

List of parameters shown in advanced mode only:

In the “Connection” section:

- Data collection and transmission blocking
- EGTS protocol settings
- Communication Server No. 2, No. 3 connection settings

Setting Overview

- GSM and SMS communication parameters
- Roaming connection parameters
- Roaming parameters

In the "RS-485 and RS-232 Interfaces Configuration" section:

- "CAN-log"
- "J1708"
- "NMEA reception"
- "NMEA transmission"
- "PP-01"
- "Camera"
- "DV-01"
- "Tachograph VDO"
- "iQFreeze"
- "TPMS Pressure Pro"
- "ALM Weight Indicator"
- "Carrier Reefer"

In the "Auxiliary equipment" section:

- Panic button parameters
- Accelerometer parameters

Sections "Universal inputs", "CAN", "Identification", "Geofences", "Outputs", "Driving Control".

Operation Parameters Setting

Remote Configuration Server (RCS)

To connect to the configuration server, open the browser and in its address bar enter the address <http://config.omnicomm.ru:9911/#en>. A window will open:

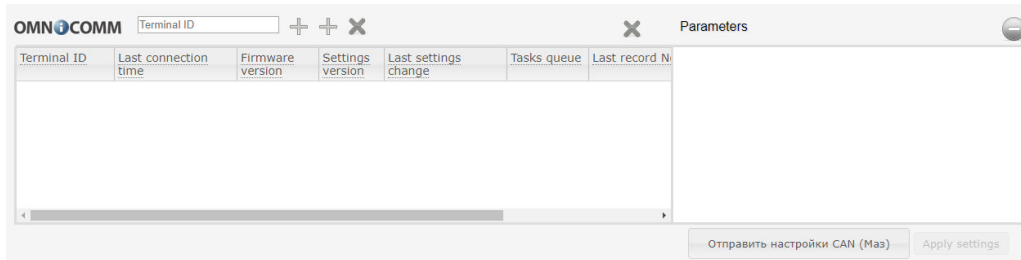

To add terminals:

1. In the "Terminal ID" field enter the terminal identification number
2. In the "Password" field enter the password set in the terminal during its setting using Omnicomm Configurator
3. Press the "+" button

Operation Parameters Setting

GPRS Connection

In the "**Settings**" tab select the "**Connection**" section from the list.

In the "**GPRS Setup**" section:

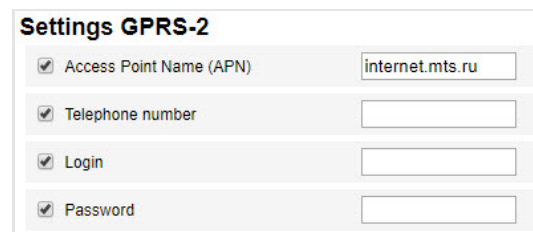
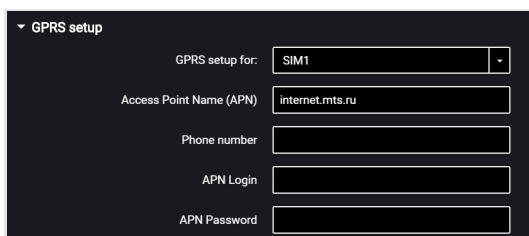

"Access Point Name (APN)" – enter the GPRS access point name

- "VimpelCom" (Beeline) – internet.beeline.ru
- "MTS" – internet.mts.ru

Operation Parameters Setting

- “MegaFon” – internet

For GPRS access point names of other operators, refer to the mobile network operator, whose SIM card is inserted in the terminal.

“Phone number” – number of the SIM card inserted in the terminal.

“APN Login” and “APN Password” – if necessary, enter login and password for APN access point. Login and password are provided with the SIM card of a number of mobile network operators.

Connection to Communication Servers for Light

Terminals support data transmission to two Communication Servers (CS) through Omnicomm and EGTS protocols.

In the “**Settings**” tab select the “**Connection**” section from the list.

In the “**EGTS Protocol Settings**” section:

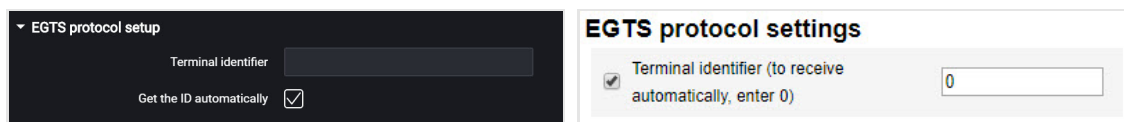

The image shows two side-by-side screenshots of the EGTS protocol settings interface. The left screenshot is a dark-themed mobile app view titled "EGTS protocol setup" with a "Terminal identifier" input field and a checked "Get the ID automatically" checkbox. The right screenshot is a light-themed desktop view titled "EGTS protocol settings" with a checked checkbox for "Terminal identifier (to receive automatically, enter 0)" and an input field containing the value "0".

When setting up EGTS data transmission, you must use the TID terminal identification.

If the settings are not configured, when transmitting data through EGTS protocol ID Omnicomm will be used for terminal identification.

In the “**Settings of connection to the communication server**” sections:

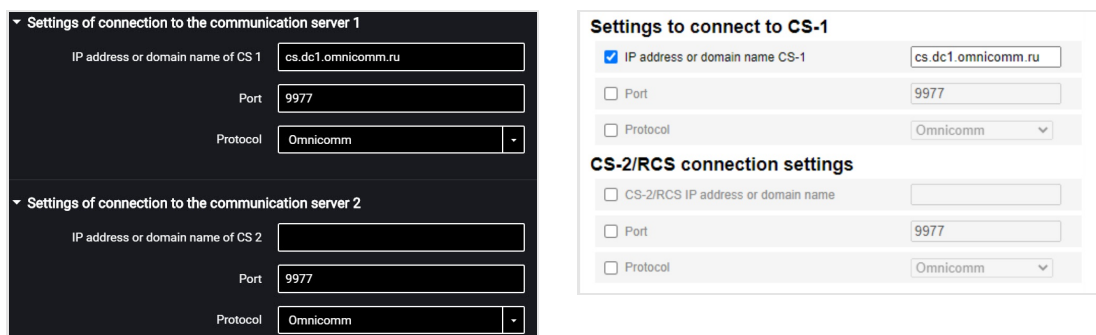

The image shows two side-by-side screenshots of the communication server connection settings interface. The left screenshot is a dark-themed mobile app view titled "Settings of connection to the communication server 1" and "Settings of connection to the communication server 2", each with fields for IP address or domain name, Port (9977), and Protocol (Omnicomm). The right screenshot is a light-themed desktop view titled "Settings to connect to CS-1" and "CS-2/RCS connection settings", with checkboxes for each section and corresponding fields for IP address, Port (9977), and Protocol (Omnicomm).

“IP address or domain name of CS 1” – enter IP address or domain name of the communication server: cs.dc1.omnicomm.ru.

“Port” – enter port to be used by terminal to connect to the communication server: 9977

“Protocol” – select data transmission protocol to the CS. Possible options: Omnicomm or EGTS.

Operation Parameters Setting

Data Collection

In the **“Settings”** tab select the **“Connection”** section from the list.

In the **“Data collection parameters”** section:

“Data collection timer” – set the value of the period of Terminal requesting modules and external devices connected to it. Default value - 15 seconds. Value range - from 1 to 240 seconds (except for Smart). Value range for Smart - from 15 to 240 seconds.

When the collection timer is set between 5 and 1 sec., the volume of the collected data will increase significantly. Taking into account the limits of data transmission speed in the second generation networks (2G), this can lead to a delay in displaying data in Omnicomm Online and, when the mobile coverage is absent for a long time, it also can lead to a complete or partial overwrite of the terminal archive and, consequently, loss of data.

“Operation with ignition off and power on” select:

- “Collect all data” – data collection and transmission same as with ignition turned on
- “Collect all except GPS” – collection and transmission of data selected during configuration of the terminal, except for the GPS module data
- “Collect data at jolting” – monitoring the status of the panic button and accelerometer. If the accelerometer reading changes by more than 0.2 g or the panic button is pressed, the terminal switches to the “Collect all data” and performs data transmission to the Communication Server in 5 minutes

When selecting “Collect data at jolting” set the following configuration:

Operation Parameters Setting

- “Collect all data” – when this parameter is enabled, the terminal upon expiration of the time specified in the “Period of data sending to server” switches to the “Collect all data” mode and performs data collection and transmission to the communication server. After the data transmission the terminal switches to the “Collect data at jolting” mode.
- “Interval of data sending to the server” – the time interval between the terminal connections to CS. Possible values: from 1 to 6 hours, at intervals of 1 hour.

Depending on the set mode, the data are collected from the particular modules and external devices.

“Adaptive data collection at cornering” – enable/disable adaptive data collection on turns, which allows increasing the accuracy of displaying turns on the map by additional data collection from the GPS module more frequently than set in the “Data collection timer” parameter. This mode is active only when the terminal registers that the ignition is on.

“Collecting data on the travelled distance” – allows increasing the accuracy of displaying the vehicle location on the map by additional data collection from the GPS module over the distance travelled between the events with registered coordinates.

“Distance travelled” – enter the mileage travelled from the moment of the last registered event with coordinates, upon achieving which the data will be collected. Possible values: from 10 to 1000 meters. Default value – 100 meters.

“Coordinate drift filtering” – enable to eliminate drift of coordinates during the “Track” report generation.

When enabling the “Coordinate drift filtering” the following settings are available:

- “Delay after ignition on, sec”. Default value – 35 sec. Possible values: from 0 to 900.
- “Maximum movement speed, km/h”. Default value – 180 km/h. Possible values: from 5 to 360.

The default values allow elimination of drifts for most cases and do not require correction.

Data Transmission to a Communication Server

In the “**Settings**” tab select the “**Connection**” section from the list.

In the “**Parameters of output for connection**” section:

Operation Parameters Setting

Parameters of output for connection
Interval of sending data to the server (minutes) 2

Connection establishing parameters
 Data transfer interval to CS (min) 2

“Interval of sending data to the server” – enter the number of minutes, upon expiration of which the Terminal must establish connection with the communication server, while being in the mobile operator's home network. Recommended value – 10 minutes.

In the **“GSM and SMS communication parameters”** section:

Communication parameters of GSM and SMS
SMS Switched on
SMS destination number (SMSC)
Language of SMS template Русский
Vehicle name

GSM and SMS communication parameters
 SMS On
 Number for sending SMS
 SMS template language Russian
 VH name

“SMS” – enable/disable the commands reception via SMS and sending the information messages by the Terminal. When the “SMS” parameter is enabled:

“SMS destination number” – enter the phone number, to which the SMS will be sent with information about the status of the Terminal and the vehicle.

“Language of SMS template” – select the language of the SMS template. Possible options: Russian, English, Portuguese, Spanish.

“Vehicle Name” – enter the name of the vehicle. The “Vehicle Name” field is mandatory.

In the **“Output parameters to communicate in roaming”** section:

Output parameters to communicate in roaming
Communication By packet size
Data packet size to send to CS (kB) 300

Connection establishing in roaming parameters
 Connection establishing upon event Sending per
 Period of data transfer to CS (min) 60

Select the criterion for the terminal connection to the CS: “By time period” or “By packet size”.

“Interval of sending data to the CS” – enter the number of minutes, upon expiration of which the terminal must establish connection with the communication server, while being in roaming. Recommended value – 180 minutes.

“Data packet size to send to CS” – enter the data packet size, upon achieving which the terminal must establish connection with the communication server, while being in roaming. Recommended value – 100 Kb.

In the **“Roaming settings”** section:

Operation Parameters Setting

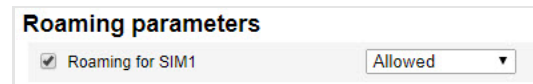
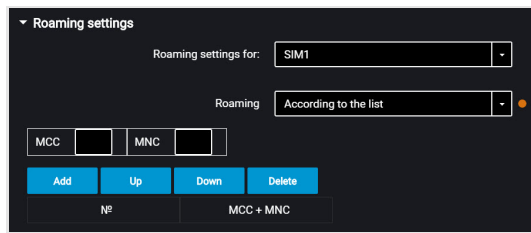

“Roaming” – select the option of SIM card using while in roaming. Possible options: “Permitted”, “Forbidden” or “According to the List”.

To use the SIM card in roaming “according to the list”, in Omnicomm Configurator, enter the MCC and MNC table of authorized cellular networks.

Selection of Ignition Source

In the “**Settings**” tab select the “**Inputs**” section from the list.

In the “**Ignition key status**” section:

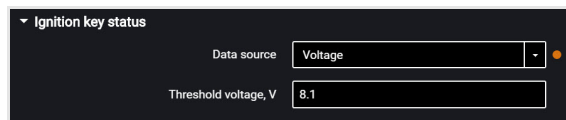

“Data source” – select the data to register ignition on/off.

Possible options:

“Ignition key” – the ignition on/off is registered on the position of the key upon direct connection to the ignition key.

“Onboard voltage” – the ignition on is registered upon reaching the vehicle network power supply threshold voltage. Specify the value “Threshold voltage, V” – the value of the vehicle network power supply voltage, upon reaching which the ignition on will be registered. Ignition off is registered, when the voltage drops to 0.5 V below the threshold.

Selection of Speed Source

In the “**Settings**” tab select the “**Inputs**” section from the list.

In the “**Vehicle speed**” section:

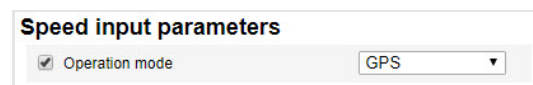
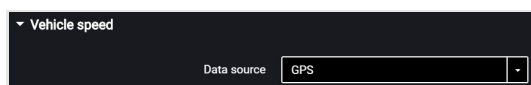

“Data source” – select the data to process the speed values. Possible options: “GPS” or “CAN bus”.

Operation Parameters Setting

Engine RPM

In the **“Settings”** tab select the **“Inputs”** section from the list.

In the **“Engine RPM”** section:

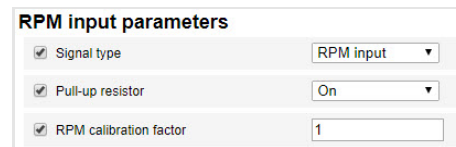
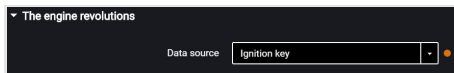

“Data source” – select the signal type. Possible values:

- “Disabled”
- “Ignition key”
- “CAN bus”
- “RPM input”

Connect the tachometer to the Smart and Light Terminals according to the diagram:

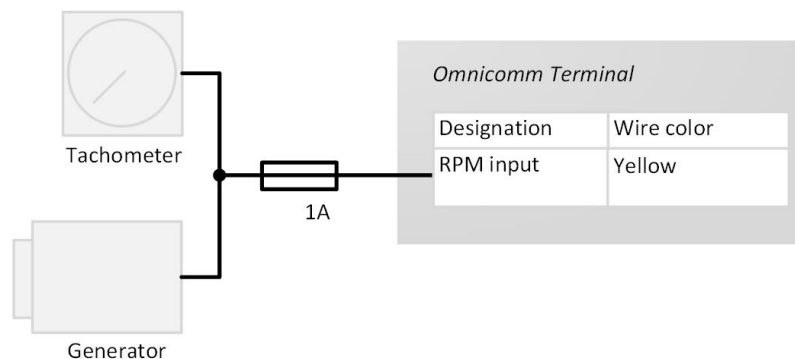

The place of connection to the tachometer shall be the point in the vehicle electric network, in which the pulse signal frequency is proportional to the engine RPM.

Driving Safety Control

In the **“Settings”** tab select the **“Auxiliary equipment”** section from the list.

In the **“Accelerometer parameters”** section:

Operation Parameters Setting

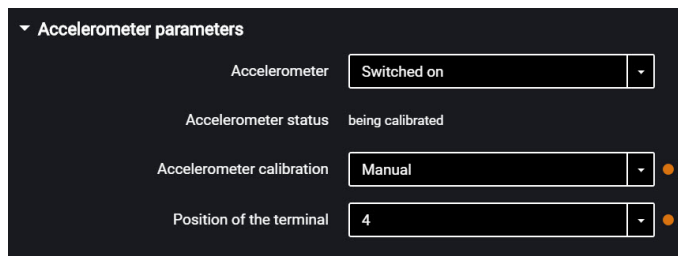

“Accelerometer” – enable/disable the use of accelerometer for measuring the vehicle acceleration.

“Accelerometer status” – accelerometer condition. Possible options: not used, calibration, calibrated, calibration error.

“Accelerometer calibration” – select the accelerometer calibration mode. Possible options: automatic calibration, manual calibration.

Prior to performing the calibration, firmly fix the terminal and do not change its position during operation.

Automatic calibration is recommended for vehicles that are operated mainly at speeds above 50 km/h. Automatic calibration takes from 2 minutes to 24 hours depending on the frequency of accelerations and braking on straight sections of the road.

When selecting manual calibration, in the “Position of the terminal” field, select one of 24 positions as shown in figure

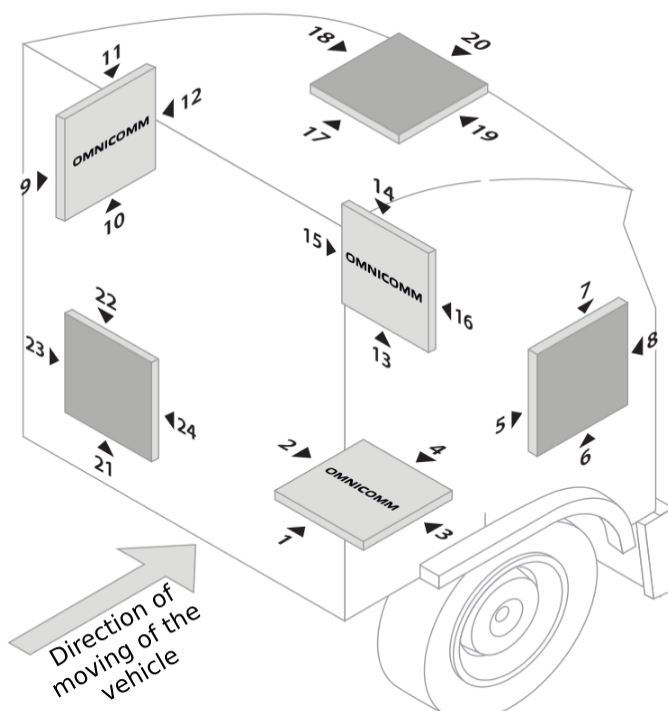

Arrow ► indicates the location of the terminal connector.

The “Omnicommm” inscription in the figure corresponds to the top cover of the terminal.

Operation Parameters Setting

Deflection of the terminal from the axes during manual calibration should not be more than 5 degrees.

In the **“Settings”** tab select the **“Driving Control”** section from the list.

“Control of dangerous driving” – enable/disable registration of dangerous driving when exceeding the set values of monitored parameters.

	Sending an event	Threshold	Inaccuracy	Duration, sec	Sound notification
Speed, km/h	<input checked="" type="checkbox"/>	80	5	15	<input checked="" type="checkbox"/>
Engine speed (RPM)	<input checked="" type="checkbox"/>	4000	200	15	<input type="checkbox"/>
Acceleration, g	<input checked="" type="checkbox"/>	0.20			<input type="checkbox"/>
Lateral acceleration, g	<input checked="" type="checkbox"/>	0.20			<input type="checkbox"/>
Braking, g	<input checked="" type="checkbox"/>	0.20			<input checked="" type="checkbox"/>
Vertical acceleration (jolt/shock)	<input checked="" type="checkbox"/>	0.40			<input type="checkbox"/>
Speed AND threshold excess of universal input1	<input type="checkbox"/>	12			<input type="checkbox"/>
Speed AND threshold excess of universal input2	<input type="checkbox"/>	54			<input type="checkbox"/>

Select monitored parameters:

“Sending an event” – enable/disable event sending to Omnicomm Online.

- “Speed” – vehicle speed control

Threshold – enter the maximum permissible speed, upon exceeding which dangerous driving will be registered. Possible values: from 0 to 150 km/h. Default value: 80 km/h.

Deviation – enter the speed value that can be exceeded maximum permissible speed without triggering dangerous driving. Possible values: from 0 to 50 km/h. Default value: 5 km/h.

Duration – enter the period of time allowed to exceed maximum permissible speed without triggering dangerous driving. Possible values: from 0 to 300 s. Default value: 15 s.

- “Engine speed (RPM)” – engine RPM monitoring

Threshold – enter the maximum permissible engine RPM, upon exceeding which dangerous driving will be registered. Possible values: from 0 to 10,000 rpm. Default value: 4,000 rpm.

Deviation – enter the RPM value that can be exceeded by maximum permissible RPM without registration of violation. Possible values: from 0 to 1000 rpm. Default value: 200

Operation Parameters Setting

rpm.

Duration – enter the period of time allowed to exceed maximum permissible engine RPM without registration of dangerous driving. Possible values: from 0 to 300 s. Default value: 15 s.

- “Acceleration” – acceleration control during vehicle speeding up

Threshold – enter the value of acceleration while speeding up, which exceeding will trigger registration of dangerous driving

- “Lateral acceleration” – acceleration control during vehicle turning

Threshold – enter the value of acceleration while turning, which exceeding will trigger registration of dangerous driving

- “Braking” – acceleration control during vehicle braking

Threshold – enter the value of acceleration while braking, which exceeding will trigger registration of dangerous driving

- “Vertical acceleration (jolt / shock)” – acceleration control during vehicle jolting

Threshold – enter the value of acceleration while jolting or shocking, which exceeding will trigger registration of dangerous driving

- “Speed and threshold exceeding of potential UI1”

Threshold – enter the value of speed, which exceeding will trigger registration of violation, if universal input No.1 is closed/open.

- “Speed and threshold exceeding of potential UI2”

Threshold – enter the value of speed, which exceeding will trigger registration of violation, if universal input No.2 is closed/open.

The notification for the event "Speed and Exceeding of threshold of potential UI1, UI2" is generated only when the selected speed source is "GPS". (see [Selection of Speed Source](#)).

- “Send an SMS for selected events” – enable SMS sending upon registration of dangerous driving
- “Send a photo for selected events” – enable digital camera photo sending upon registration of dangerous driving

Operation Parameters Setting

“Sound notification” – enable/disable sound notification if thresholds of monitored parameters are exceeded. To run sound notification connect a sound emitter to controlled output No.1.

“Identify an accident” – enable/disable accident registration upon exceeding the set values of monitored parameters.

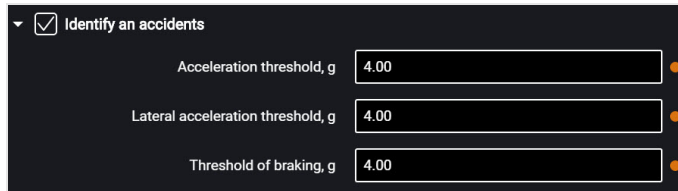

- “Acceleration threshold” – value of acceleration while speeding up, which exceeding will trigger registration of accident
- “Lateral acceleration threshold” – value of acceleration while turning, which exceeding will trigger registration of accident
- “Threshold of braking” – value of acceleration while braking, which exceeding will trigger registration of accident
- “Send SMS upon triggering” – enable SMS sending upon registration of accident
- “Send photo upon triggering” – enable digital camera photo sending upon registration of accident

“Load on axes” – enable/disable control of vehicle axle load and total vehicle load.

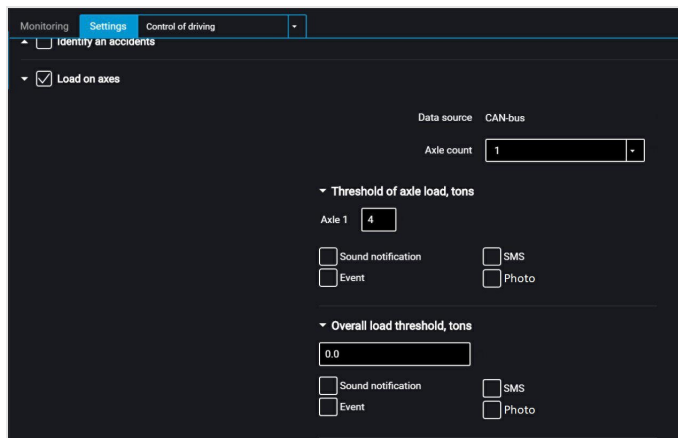

“Data source” displays the axle load data source. Possible options: ALM Weight Indicator and CAN.

To select the ALM Weight Indicator as a data source choose Indicator in the RS-485 or RS-232 interface configuration.

To select the CAN bus as a data source enable SPN 582 and SPN 928 in the CAN settings

Operation Parameters Setting

tab.

If the ALM Weight Indicator and the CAN Bus are both set as data source, the ALM Weight Indicator will be used.

“Axle count” – set the number of vehicle axles. Possible values: from 1 to 8. Maximum value – 8 for CAN, 6 for ALM.

“Threshold of axle load, tons” – enter the value of load on each axle, upon exceeding which an event will be registered.

- “Sound notification” – enable/disable sound notification if thresholds of monitored parameters are exceeded.
- “Events” – enable/disable event sending to Omnicomm Online
- “Photo” – enable digital camera photo sending upon load exceeding
- “SMS” – enable SMS sending upon load exceeding

“Overall load threshold, tons” – enter the value of total vehicle load, upon exceeding which an event will be registered.

- “Sound notification” – enable/disable sound notification if thresholds of monitored parameters are exceeded.
- “Events” – enable/disable event sending to Omnicomm Online
- “Photo” – enable digital camera photo sending upon total load exceeding
- “SMS” – enable SMS sending upon total load exceeding

Case Tampering Control

In the “**Settings**” tab select the “**Auxiliary equipment**” section from the list.

In the “**Case tampering detection**” section:

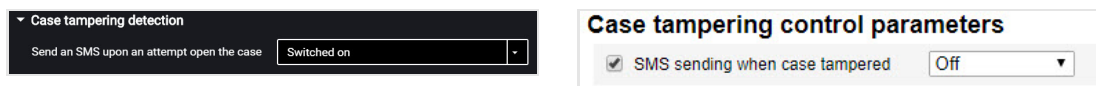

“Send an SMS upon an attempt open the case” – enable/disable SMS sending upon triggering the body tampering sensor.

Internal Battery for Light

In the “**Settings**” tab select the “**Auxiliary equipment**” section from the list.

Operation Parameters Setting

In the **“Parameters of internal accumulator”** section:

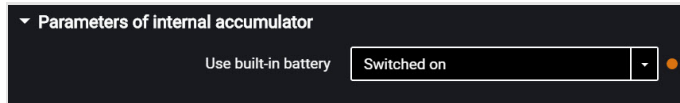

“Use built-in battery” – enable/disable use of internal battery when the main power supply is turned off and the terminal is operating in the “Collect data at jolting” mode.

GPS / GLONASS Signals Jamming Detector for Light

For Omnicomm Light terminals in the **“Settings”** tab select the **“Auxiliary equipment”** section from the list.

In the **“GPS / GLONASS Signals Jamming Detector”** section:

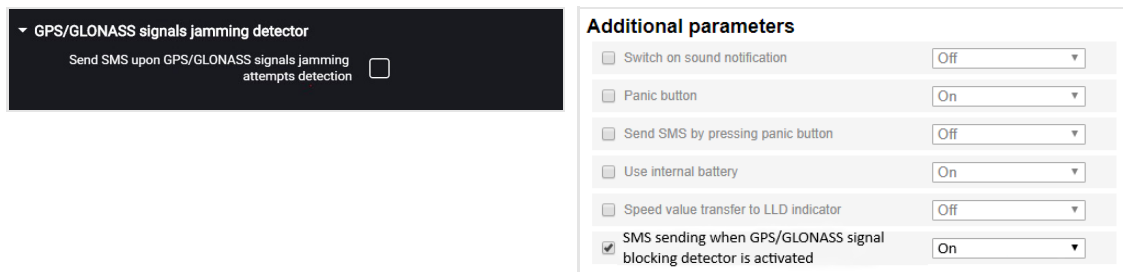

“Send SMS upon GPS/GLONASS signals jamming attempts detection” – check the box to send SMS upon registering the jamming of GPS / GLONASS.

GPS/GLONASS jamming detector can be activated when SMS configuration is enabled (see [GSM and SMS parameters](#)).

GSM Signal Jamming Detector for Light

For Omnicomm Light terminals in the **“Settings”** tab select the **“Auxiliary equipment”** section from the list.

In the **“GSM Signal Jamming Detector”** section:

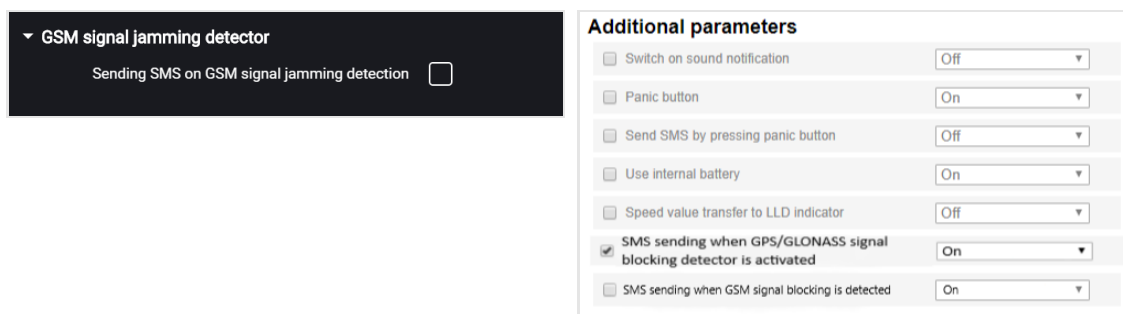

Service Functions

GSM jamming detector can be activated when SMS configuration is enabled (see [GSM and SMS parameters](#)).

“Sending SMS on GSM signal jamming detection” – check the box to send SMS upon registering the GSM network signal jamming.

Service Functions

Terminal Reboot

In the “Service” menu select “Restart Terminal”.

Setting Password on Configuration Changing

In the “**Settings**” tab select the “**Auxiliary equipment**” section from the list.

In the “**Configuring a password**” section:



If you need to use a password to configure the terminal settings, in the field “Ask for the password when saving settings” select “Enabled”. Press the “Record into device” button. A window will open:

Service Functions

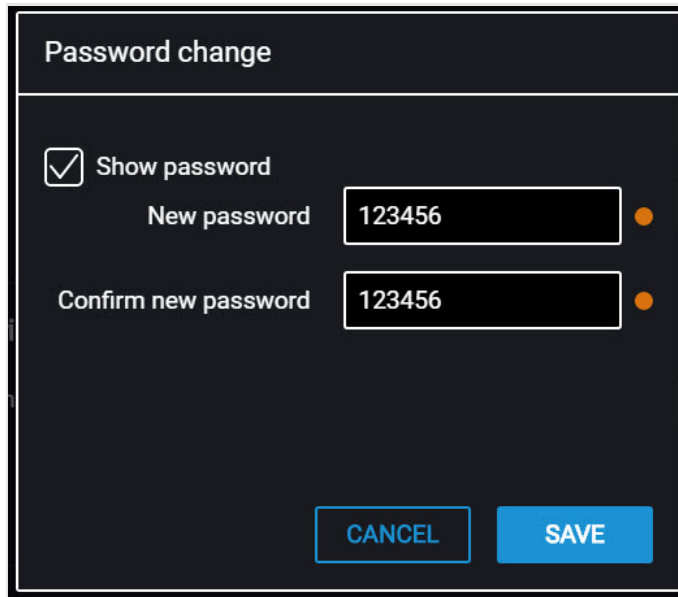

Password change

Show password

New password 123456

Confirm new password 123456

CANCEL SAVE

“New password” and “Confirm new password” – enter the password, which will be used to get access to settings configuration. The password shall contain 8 characters maximum.

Press the “Save” button. A window will open:

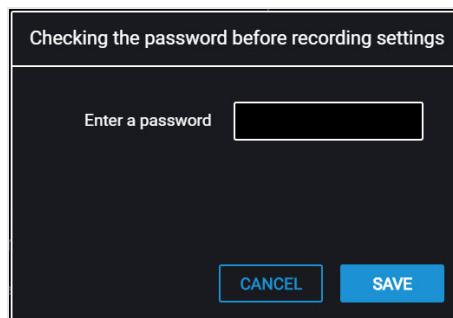

Checking the password before recording settings

Enter a password

CANCEL SAVE

Press the “Ok” button.

Press the “Record into device” button.

Service Functions

Data Collection and Transmission Blocking

In the **“Settings”** tab select the **“Connection”** section from the list.

In the **“Blocking of information collection and transfer”** section:

To block the terminal data collection and transmission in the **“Lock”** field select **“Enabled”**:

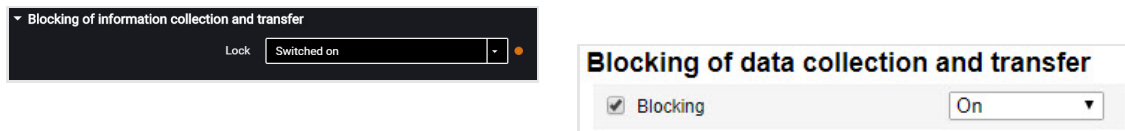

To unlock data collection and transmission use Omnicomm Configurator or send SMS command ***UNBLOCK#** to the SIM card, inserted in the terminal.

Remote Configuration Server Operation Setting

Set password on terminal settings modification by either of the following ways

- When configuring the terminal using Omnicomm Configurator set password on settings modification that is different from the password set by default. Password set by default – empty line
- Send SMS command to change password set by default: ***SETPWDID 235009988 12345#**

where: 235009988 – terminal ID; 12345 – password to be set. The password shall contain 8 characters maximum and may include any digits and letters.

The previously set password cannot be changed in this way.

After 6 hours, the terminal will be authorized on the Remote Configuration Server and will be available for operation via the Remote Configuration Server.

Service Functions

Terminal SIM Card Number Identification

The terminal SIM card telephone number is automatically displayed in the Remote Configuration Server after the second connection to the RCS.

SMS sending shall be enabled for the SIM card.

The Set Up and an Update of Built-in Firmware for the Omnicomm LLS 5 and LLS-Ex 5 Fuel Sensors

When Omnicomm LLS 5 and LLS-Ex 5 fuel sensors are connected to the video-terminal with an built-in firmware version FW310 or later, there is a possibility to update firmware and change settings via the Remote Configuration Server.

You can set up or update the firmware only one sensor at a time. The value of the network address of the sensor shall be between 1 and 6.

In the remote configuration server in the **“RS port settings”** click on **“LLS parameters”**:

The screenshot shows a window titled "LLS parameters" with three tables, each representing a different sensor configuration. Each table has two columns: "Parameter" and "Value".

Parameter	Value
Network address	1
Sensor type	LLS 5
UID	0036000857345234393320
Rate	19200 bit/s
Initialization	not implemented
Adjustment	on
Filter length	Medium
LLS firmware version	5.0.2.3
Update to version	Update is available
Status update	not planned

Parameter	Value
Network address	2
Sensor type	LLS 5
UID	004b000857345234393320
Rate	19200 bit/s
Initialization	not implemented
Adjustment	on
Filter length	Maximum
LLS firmware version	5.0.2.3
Update to version	Update is available
Status update	not planned

Parameter	Value
Network address	3
Sensor type	LLS 5
UID	004f001357345435323720
Rate	19200 bit/s
Initialization	not implemented
Adjustment	on
Filter length	Medium
LLS firmware version	5.0.2.3
Update to version	Update is available
Status update	not planned

At the bottom right of the window are "Save" and "Cancel" buttons.

“Network address” – a network address of the Omnicomm LLS fuel sensor will be displayed.

“Sensor type” – the type of the fuel sensor will be displayed Possible options: LLS 5 and LLS-Ex 5.

“UID” – sensors identification number.

“Date rate” – connection data rate with external device.

“Initialization” – the accuracy of the «Full/Empty» calibration for the main and REF-

Auxiliary Equipment

channel will be displayed. Possible options: completed - the «Full/Empty» calibration for the main and REF-channel was completed successfully and the default values were changed; not completed - the «Full/Empty» calibration for the main and REF-channel was not completed, the default values were set.

“Automatic adjustment” – enable to automatically correct the measurements when the dielectric constant of the fuel changes. Upon activation of automatic adjustment, changes of level caused by thermal expansion of fuel will be displayed, i.e. the level will be shown considering the current temperature. The setting is available only after the sensor has been calibrated.

“Filtering” – please insert the value of the filters length according to filtration. Possible options: no, minimum, medium, maximum.

“Sensors Firmware version” – the fuel sensors in-built firmware version will be displayed.

“Update to version” – select the version of the in-built firmware of the sensor when the update is necessary. If a newer version is available, “Update available” is displayed.

“Update status” – the status of the update will be displayed. Possible options: planned, not planned.

Sensor settings will be updated and / or changed after the connection between the terminal and the remote configuration server is established.

Auxiliary Equipment

RS-485 Interface

Connection of auxiliary equipment (CAN-Log, PP-01 passenger sensors, DV-1 driver display, JPEG camera, data reception from vehicle J1708 data bus, reception and transmission of navigation data as per NMEA standard) is carried out through RS-485 interface. When needed, it is recommended to use the RS-232 to RS-485 converter.

In the “Settings” window open the “Inputs” tab:

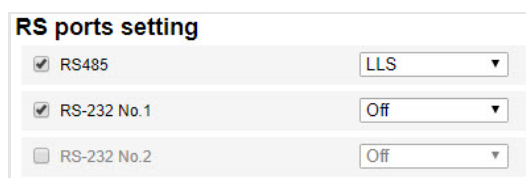
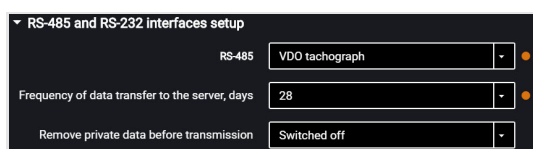

For RS-485 interface choose the setting:

- “Disabled” – interface is not used

Auxiliary Equipment

- “LLS / LLD / ICON”- used to connect the Omnicomm LLS fuel level sensors, Omnicomm LLD indicator, Omnicomm ICON display.
- “ALM Weight Indicator” – use for connection to the axle load monitoring device
- “CAN-Log” (only for Light) – connection to a CAN-log device
- “J1708” (only for Light) – connection to the vehicle J1708 data bus
- “NMEA reception” (only for Light) – use of navigation data from an external device. If you select this option, you must specify the data port bit rate. “RS port bit rate for NMEA data” – select the data port bit rate for reception of navigation data from an external device
- “NMEA transmission” (only for Light) – use of the terminal navigation data in an external device.
- “PP-01” (only for Light) – use for connection of the passenger sensor
- “Camera” (only for Light) – use for the digital camera connection
- “DV-01” (only for Light) – use for the driver display connection
- “Tachograph VDO” (only for Light) – use for Continental tachograph connection

“Frequency of data transfer to the server” – select the number of days for the DDD files transmission to the communication server. Possible options: from 1 to 28 days.

“Remove private data before transmission” – if necessary, enable deleting the driver's personal data prior to data sending to the server.

- “iQFreeze” (only for Light) – use for connection of the refrigerator control device
- “Modbus (Struna +, PMP-201)” (only for Light) – use for connection to the level gauge PMP-201 or the Struna + system

Fuel Level Sensors

In the “**Settings**” tab select the “**Inputs**” section from the list.

In the “**Fuel Level Sensors**” section:

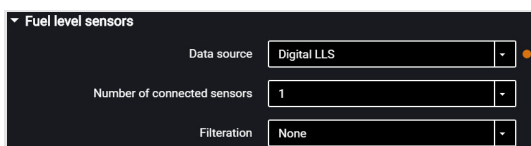

Fuel level sensors

Data source: Digital LLS

Number of connected sensors: 1

Filteration: None

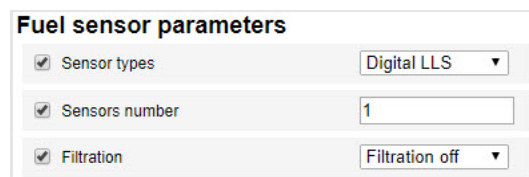

Fuel sensor parameters

Sensor types: Digital LLS

Sensors number: 1

Filtration: Filtration off

“Data source” – select the type of fuel level sensors. Possible options:

Auxiliary Equipment

- "Digital LLS" – when connecting fuel level sensors Omnicomm LLS
- "Frequency LLS-AF" – when connecting fuel level sensor Omnicomm LLS-AF
- "Vehicle sensor" – when connecting the vehicle standard fuel sensor
- "CAN Bus" – when connecting to the CAN bus
- "Struna +" (only for Light) – when connecting to the "Struna +" system
- "PMP-201" (only for Light) – when connecting the level gauge PMP-201
- "Disabled" – in case fuel level control is not required.

When Omnicomm LLS and Omnicomm LLS-AF fuel level sensors are connected:

"Number of connected sensors" – specify the number of sensors connected to the terminal.

When choosing LLS fuel level sensors connected to a universal input, you need to configure the universal input. For automatic configuration of the universal input in Omnicomm Configurator press the "Configure UI" button.

"Filtration" – enter the size of inner filter. Possible filtration options:

- "None" – filtration is performed only according to the settings in the Omnicomm LLS sensor
- "Low" – used in case of the sensor installation in stationary fuel storages and non-mobile machinery
- "Medium" – used in case of vehicle's operation in normal road conditions
- "Strong" – used in case of vehicle's operation in normal and severe road conditions
- "Maximum" – this filtration is used in case of vehicle's operation in severe road conditions and when connecting a standard fuel sensor with analog output

Auxiliary Equipment

Connect Omnicomm LLS fuel level sensor according to the diagram:

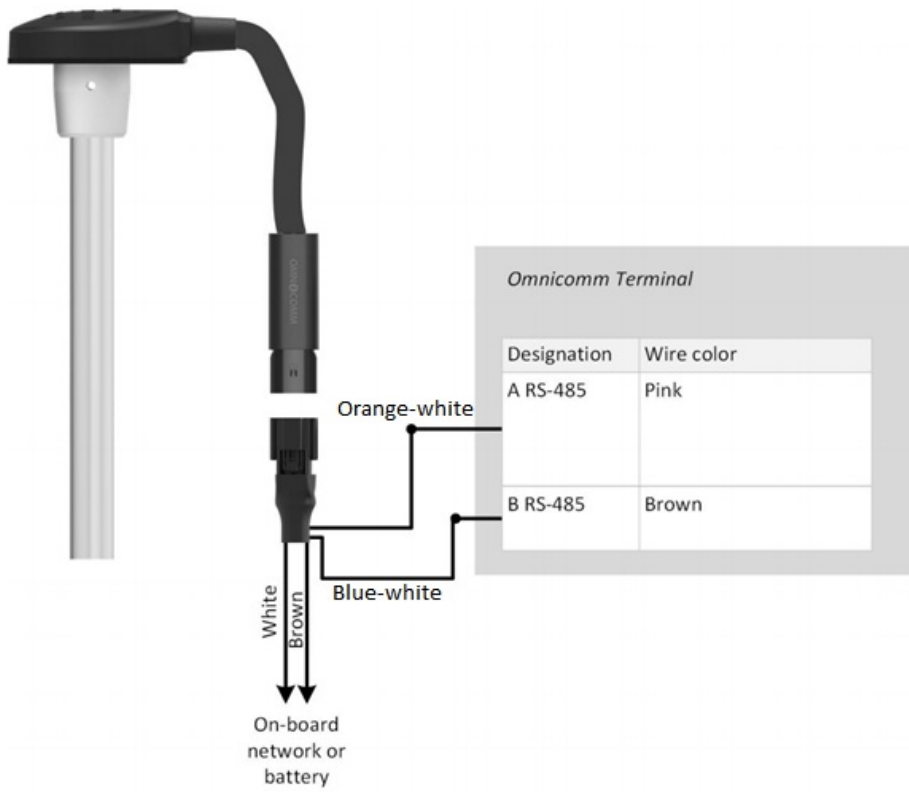

Auxiliary Equipment

Connect Omnicomm LLS-AF fuel level sensor according to the diagram:

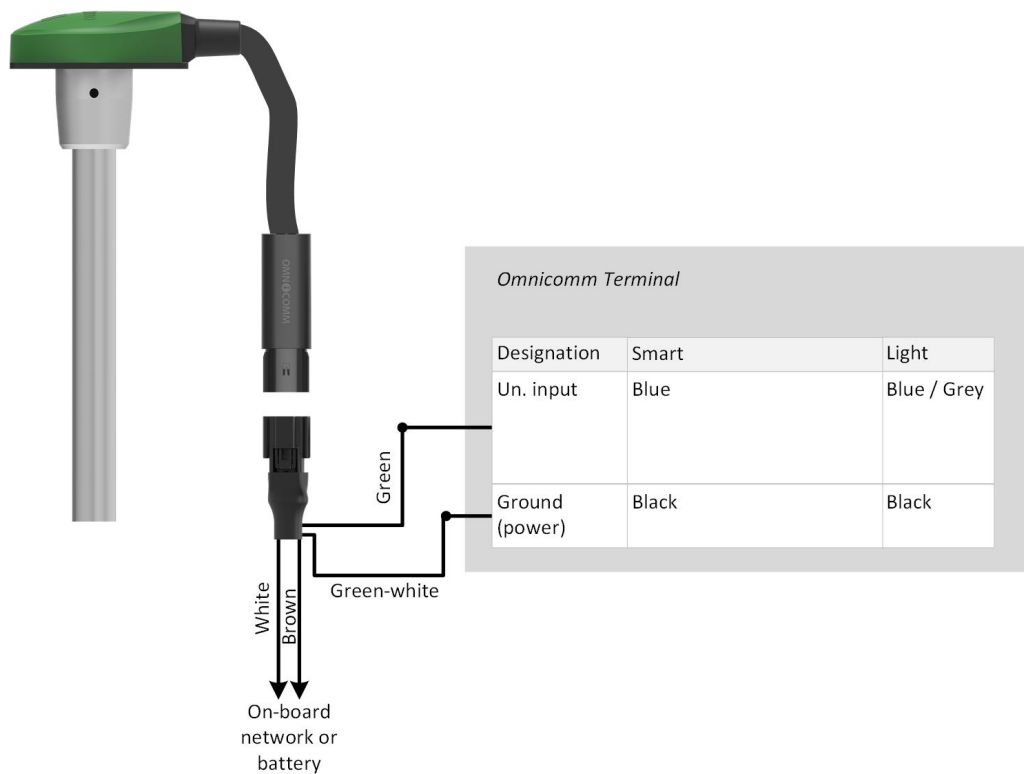

Connect several Omnicomm LLS-AF sensors to the Light terminal one by one, starting with 1 universal input.

Omnicomm LLS-AF sensor must be set to output a frequency signal in the range from 30 to 1053 Hz.

When connecting the Omnicomm Light terminals to the "Struna +" system or the "PMP-201" sensor:

- "Fuel tank volume, L" – enter the fuel tank volume. Possible values: from 0 to 65,000
- "Current fuel volume, L" – displays the current volume according to the "Struna +" system or the "PMP-201" sensor

Connect the "PMP-201" sensor and the "Struna +" system according to the documentation on these devices. You may connect only one "Struna +" system. The network address, by default, is 80.

Auxiliary Equipment

Omnicom ICON Display

In the **"Settings"** tab select the **"ICON"** section from the list.

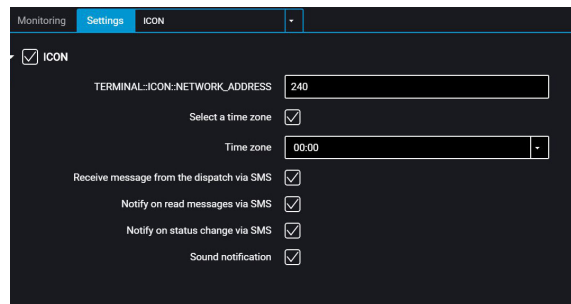

"ICON" – check the box to display the data from the terminal on the Omnicomm ICON display

- **"Network address"** – select the display's network address. Possible values: from 7 to 254
- **"Select the time zone"** - check the box to select your time zone relative to UTC. The time zone value is used when an automatic registration of time zones is not required

"Time zone" – select the time zone

- **"Receive messages from the dispatch via SMS"** - check the box to show messages addressed to the terminal's SIM card on the display. Format of outgoing messages: D2d dispatcher text. Maximum message length: 128 characters.
- **"Notify on read messages via SMS"** - check the box to send a notification when SMS messages have been read. Notifications will be sent to the dispatcher's number, indicated during the terminal setup (see [Connection to the communication server](#))
- **"Notify on status change via SMS"** - check the box to send a notification to the dispatcher's number when the driver's status changes. The notification will contain the driver's new status.
- **"Sound notification"** - check the box to enable sound notifications when the terminal registers a new event, as specified during the terminal's setup.

In the **"Settings"** tab select the **"Additional equipment"** section from the list.

"Engine hours by RPM", fill in the RPM to engine hours conversion table:

Auxiliary Equipment

▼ Engine hours by RPM

RPM	Coefficient
1000	0.1
5000	0.5

Add **Ctrl** **Space** Delete **Ctrl** **K**

Enter the RPM value in the “Revolutions per minute” field, in “Coefficient” field enter the value of conversion factor to calculate engine hours.

The conversion factors are determined based on the vehicle operating conditions.
Maximum number of rows – 5.

The engine hours are displayed in hours with a decimal part (1.50 equals to 1 hour and 30 minutes) in the format HH.XX within the range of up to 100 engine hours and HHH.X for 100.0 - 999.9 engine hours. If the number of engine hours is higher than 1000, the last three significant digits and one symbol after the decimal point are displayed.

All engine hours are recorded in the terminal and sent to the CS as accrued total.

Connect the Omnicomm Smart, Light terminals to the Omnicomm ICON display as shown in the figure:

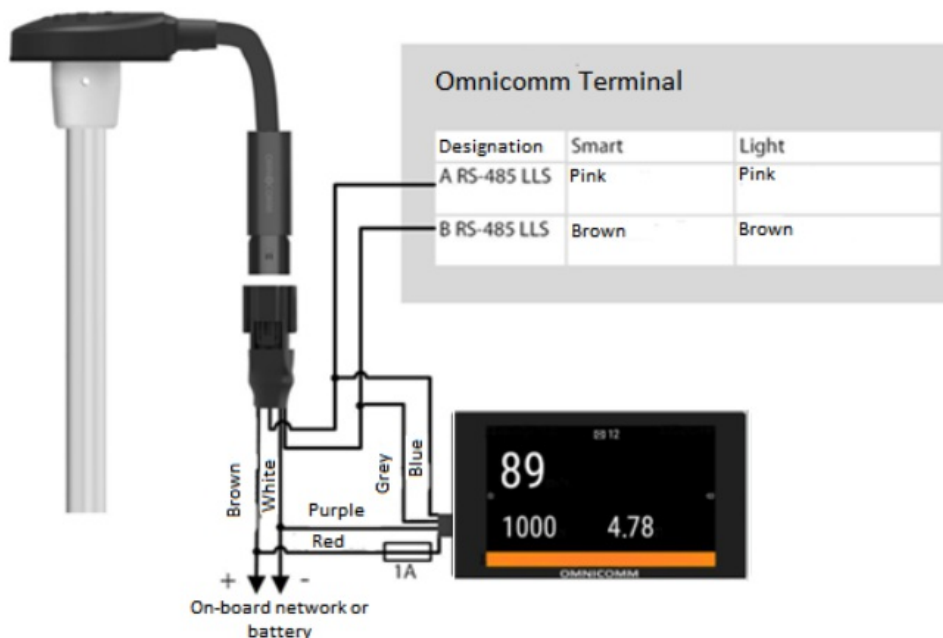

Omicomm LLD Indicator

In the “**Settings**” tab select the “**Auxiliary equipment**” section from the list.

In the “**Data transmission to Omnicomm LLD indicator**” section:

Auxiliary Equipment

Data transfer to the indicator Omnicomm LLD

Data source: Engine hours by RPM

Revolutions data source: Ignition key

Dependence of engine hours on revolutions

RPM	Coefficient
500	0.5
1000	1

Buttons: Add [Ctrl][Space], Delete [Ctrl][K]

Additional parameters

- Switch on sound notification: On
- Panic button: On
- Send SMS by pressing panic button: On
- Use internal battery: Off
- Speed value transfer to LLD indicator: On

“Data source” – select the data source to display the value on the Omnicomm LLD indicator. Possible options:

- “GPS speed” – displays the vehicle speed
- “Universal input” – displays the status or values on the terminal universal input depending on the connected auxiliary equipment
- “Engine hours by RPM” – displays vehicle engine hours

When selecting “Engine hours by RPM”, fill in the table of RPM recalculation to engine hours as follows:

In the field “Revolutions per minute” enter the value of RPM, in the field “Factor” enter the value of conversion factor to calculate the engine hours value.

The conversion factors are determined based on the operating conditions of the vehicle.

Maximum number of rows – 5.

Engine hours are displayed on the LLD indicator as hour values with a fractional part (1.50 means 1 hour 30 minutes) in the format HH.XX in the range of up to 100 engine hours and HHH.X in the range of 100.0 to 999.9 engine hours.

If the number of engine hours is more than 1000, the last three significant figures are displayed and one symbol after the decimal point.

Engine hours are fully recorded in the terminal and sent to the CS on a continuous accrual basis.

CAN-LOG controllers for Light

Omnicomm Light terminals support the connection of controllers when an RS-232/RS-485 converter is used.

Connect the CAN-LOG, series B14, B24, B34, B44, to the vehicle's CAN bus, as shown in the diagram:

Auxiliary Equipment

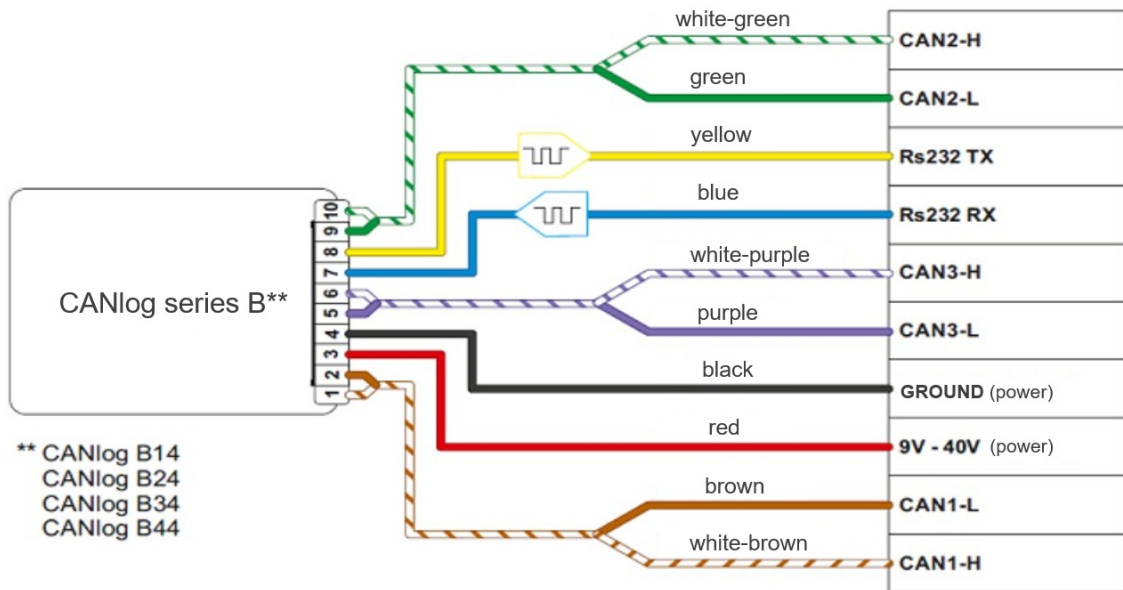

Follow the instructions provided by the CAN-LOG manufacturer during connection.

Connect the CAN-LOG to the terminal via the RS-232 interface as shown in the diagram:

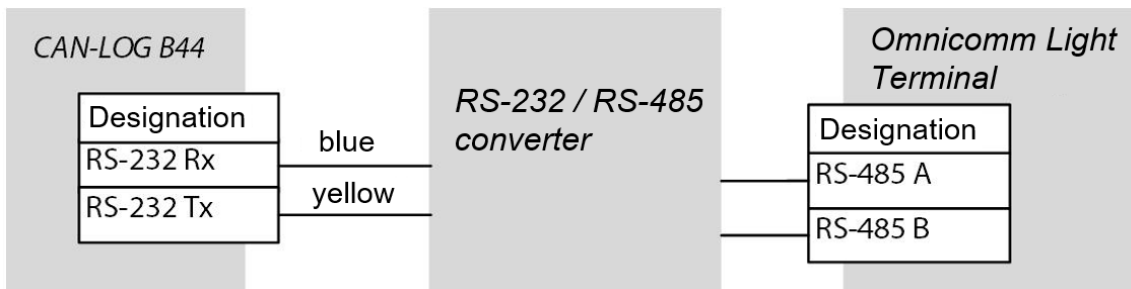

In Omnicomm Configurator, in the "Settings"/"Inputs" window, in the "RS-485 and RS-232 Interface Configuration" section:

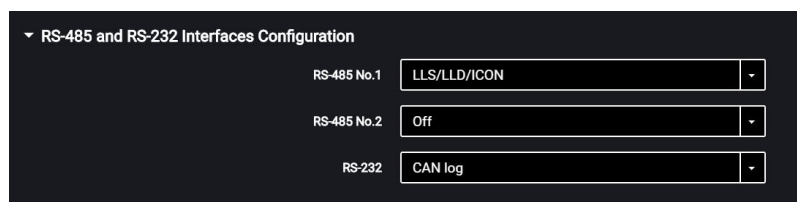

"RS-232" - select CAN log.

CAN-LOG parameters, displayed in Omnicomm Online and in Omnicomm Configurator

Auxiliary Equipment

SPN	Omnicom Online	Configurator	CAN-LOG series B V4	CAN-LOG series B V2	CAN-LOG series P V1
70	Park. brake status	Parking brake status	Yes	Yes	Yes
91	Acceler. pedal pos., %	Accelerometer pedal position (%)	Yes	Yes	Yes
96	Fuel level		Yes	Yes	Yes
110	Eng. coolant temp., °C	Engine coolant temperature	Yes	Yes	Yes
175	Eng. oil temp., °C	Engine oil temperature			Yes
182	Daily fuel cons., l	Daily fuel consumption	Yes	Yes	
190	Engine RPM, rpm	Engine RPM	Yes	Yes	Yes
244	Daily mileage, km	Daily mileage	Yes	Yes	
245	Odometer reading, km	Total mileage	Yes	Yes	Yes
247	Engine hour meter reading, hour:min	Total engine operation time	Yes	Yes	Yes
250	Fuel consumption meter reading, l	Overall fuel consumption	Yes	Yes	Yes
527	Cruise Control status	Cruise Control status	Yes	Yes	

Auxiliary Equipment

SPN	Omnicom Online	Configurator	CAN-LOG series B V4	CAN-LOG series B V2	CAN-LOG series P V1
582	Axle load, kg	Axle load	Yes	Yes	Yes
597	Serv. br. ped. status	Status of the service brake pedal	Yes	Yes	Yes
598	Clutch ped. status	Status of the clutch pedal	Yes	Yes	
914	Mileage before maintenance, km	Mileage before next maintenance	Yes	Yes	
916	Engine hours before maintenance, h	Time before next maintenance	Yes	Yes	
1624	Inst. speed, km/h	Instantaneous speed	Yes	Yes	Yes

Select the CAN parameters in Omnicomm Configurator to transfer the parameters from CAN-LOG to the Communication Server (see [CAN Bus](#)).

Universal Inputs

Universal inputs are intended for connecting the auxiliary equipment with pulse, potential, analog or frequency output and its operation monitoring.

In the **“Settings”** tab select the **“Inputs”** section from the list.

In the **“Universal Inputs”** section:

Sensors with pulse output

Auxiliary Equipment

▼ Universal inputs

Universal input #1

Operation mode

Tightening

Coefficient of impulse

Number of impulses from the input -

Current value of measured parameter -

Name of equipment

Universal input No.1

Status

Operation mode

Pull-up resistor

Calibration factor

Equipment name

“Universal input” – select “Enabled”.

“Operation mode” – select “Pulse”.

“Equipment name” – enter the monitored parameter name.

“Tightening” – select “Enabled” when working with “open collector”-type sensors or contact sensors.

“Coefficient of impulse” – enter the calibration factor converting the number of pulses to the determined physical quantity.

“Number of impulses from the input” (in Omnicomm Configurator) – number of pulses coming at the universal input.

“Current value of measured parameter” – displays the value at the input with account for the calibration factor.

Sensors with potential output

▼ Universal inputs

Universal input #1

Operation mode

Tightening

Input signal inversion

“ON” voltage threshold (V)

Current voltage on input (V) -

Current value of measured parameter 0.0

Send an SMS upon triggering

Name of equipment

Universal input No.2

Status

Operation mode

Pull-up resistor

Turn-on voltage threshold

Potential signal inversion

Equipment name

SMS sending

“Universal input” – select “Enabled”.

“Operation mode” – select “Potential”.

“Potential input activation voltage threshold” – set the value of voltage threshold, after which the terminal will record activation of the sensor. Default value – 9 V.

“Tightening” – select “Enabled” when working with “open collector”-type sensors or contact sensors.

Auxiliary Equipment

“Input signal inversion” – set “Enabled” for the sensor with open contacts or contacts closing on commission of any action.

“Current voltage on input” – value of the voltage at the universal input of the terminal.

“Current value of measured parameter” – auxiliary equipment switched on or off.

“SMS sending upon triggering” – select “Enabled” to send SMS when the potential universal input is triggered.

“Equipment name” – enter the monitored parameter name. Possible sensor types: contact or contactless digital sensors.

Connect contactless sensors (capacitance, inductance, optical or magnetic) and N-P-N sensors with “open collector”-type input according to the diagram:

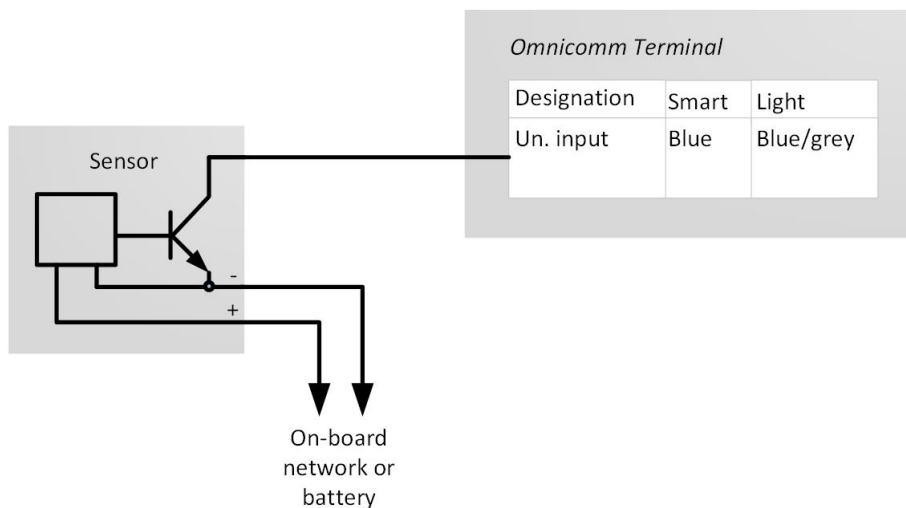

Connect contact sensor according to the diagram:

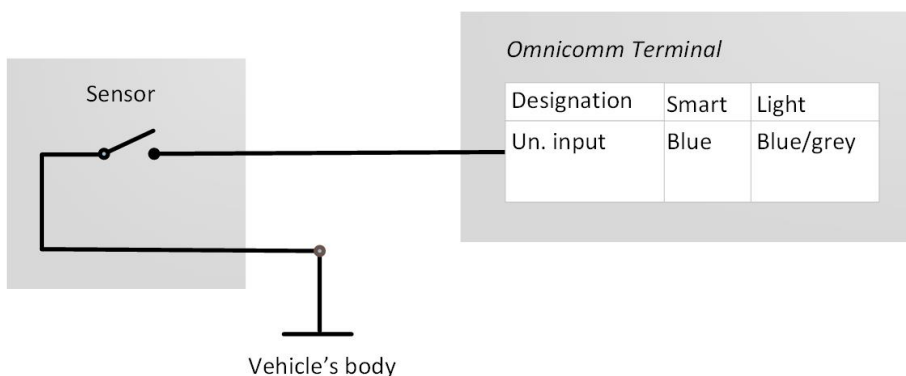

As the contact sensor you can use standard elements of equipment control (activation buttons / limit switches / sensors triggered by excess pressure or temperature, etc.) or an additionally mounted sensor. We recommend that you first look for possibility of connection to a standard device and install an additional sensor only if there is none.

Auxiliary Equipment

Sensors with analog output

▼ Universal inputs

Universal input #1: Switched on

Operation mode: Analog

Minimum value of measured parameter: 0.0

Maximum value of measured parameter: 4095.0

Voltage corresponding to minimum value of measured parameter (V): 0.0

Voltage corresponding to maximum value of measured parameter (V): 30.0

Current voltage on input (V): -

Current value of measured parameter: -

Name of equipment: Uni1

Universal input No.1

Status: On

Operation mode: Analogue

Minimum value of measured parameter: 0

Voltage corresponding to minimum value: 0

Maximum value of measured parameter: 4095

Voltage corresponding to maximum value: 30

Equipment name: Uni1

Accuracy: 0 (1)

“Minimum value of measured parameter” – set the minimum value to be measured by the sensor (in the units of measurement of this value).

“Voltage corresponding to the minimum value of measured parameter” – set the value of voltage corresponding to the minimum measured value.

“Maximum value of measured parameter” – set the maximum value to be measured by the sensor (in the units of measurement of this value).

“Voltage corresponding to the maximum value of measured parameter” – set the value of voltage corresponding to the maximum measured value.

“Current voltage at universal input” – value of the voltage at the universal input of the Terminal. “Current value of measured parameter” – current measured value.

“Equipment name” – enter the monitored parameter name. Analog sensor types:

- with current output:

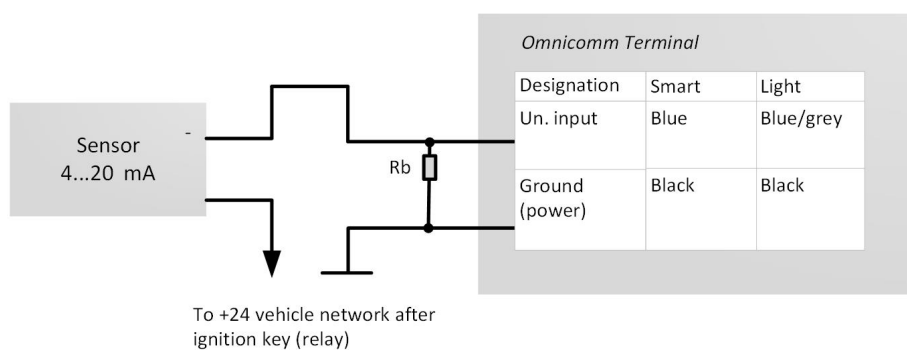

- with voltage output:

Auxiliary Equipment

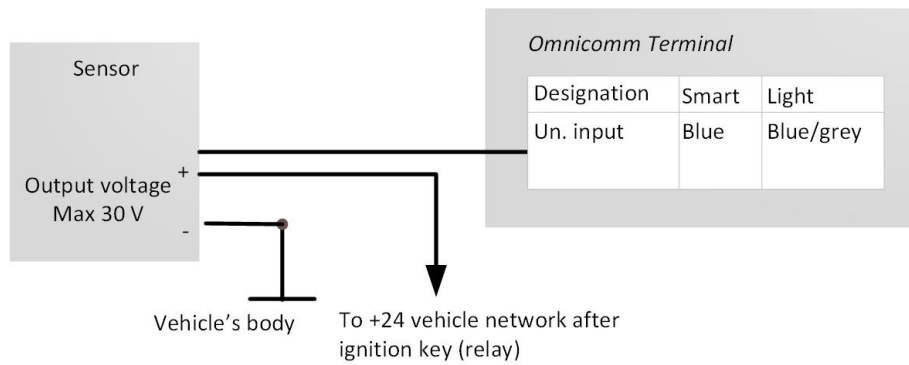

Sensors with frequency output

▼ Universal inputs

Universal input #1

Operation mode

Tightening

Current value of measured parameter -

Name of equipment

Universal input No.1

Status

Operation mode

Pull-up resistor

Equipment name

“Universal input” – select “Enabled”.

“Operation mode” – select “Frequency”.

“Tightening” – select “Enabled” when working with “open collector”-type sensors or contact sensors.

“Current value of measured parameter” – current measured value.

“Equipment name” – enter the monitored parameter name.

Driver Identification

In the “**Settings**” tab select the “**Identification**” section from the list.

Auxiliary Equipment

Monitoring Settings Identification

▼ Identification settings

Use for identification Omnicom ICON

Identification method Retention

▼ Permitted cards + Add card

Driver name	Code
Enter name	Enter code

▼ Permitted card identified

Output on Off

“Use for identification” – Omnicomm ICON

“Identification method” – select the method of identification. Possible options:

- “Applying” – the identification is performed when a card or a key is applied for the period of time specified in the parameter “Key/card identification time”.
- “Retention” – identification is performed by holding the card on the reader. This method is applied for identification via Omnicomm ICON display using the cardholder.

“Card identification duration” – specify the time value when iButton/card key is applied, after which will be enabled the second digital output of the terminal. Possible values: from 0 to 60 seconds.

In **“Permitted cards”** section, click **“Add card”** button and insert the card number. For automatic reading of the card number, connect Omnicomm ICON display to the terminal, switch on the readout mode and apply card.

If no card is indicated in this section, the events will be recorded for all applied cards.

Controlled equipment for Light

In the terminals, for each controlled output, up to three operation rules are provided.

The rules are set by event or by a combination of events and states.

In the **“Settings”** tab select the **“Outputs”** section from the list:

Auxiliary Equipment

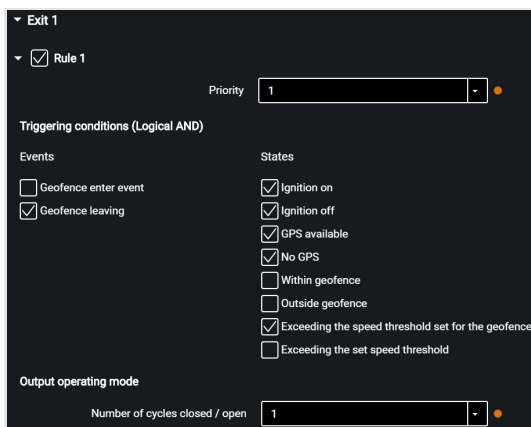

Exit 1

Rule 1

Priority: 1

Triggering conditions (Logical AND)

Events

- Geofence enter event
- Geofence leaving

States

- Ignition on
- Ignition off
- GPS available
- No GPS
- Within geofence
- Outside geofence
- Exceeding the speed threshold set for the geofence
- Exceeding the set speed threshold

Output operating mode

Number of cycles closed / open: 1

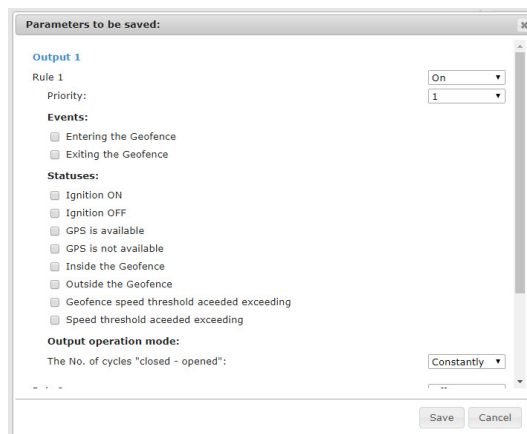

Parameters to be saved:

Output 1

Rule 1

Priority: On

Priority: 1

Events:

- Entering the Geofence
- Exiting the Geofence

States:

- Ignition ON
- Ignition OFF
- GPS is available
- GPS is not available
- Inside the Geofence
- Outside the Geofence
- Geofence speed threshold exceeded
- Speed threshold exceeded

Output operation mode:

The No. of cycles "closed - opened": Constantly

Save Cancel

“Rule priority” – set the priority of the rule. When at the same time several rules apply, a rule with the highest priority is used.

Possible options: 1 (highest), 2, 3 (lowest).

Select “Events”:

- Entering the geofence
- Leaving the geofence

Select “States”:

- Ignition on
- Ignition off
- GPS available
- No GPS
- Being in geofence
- Being outside geofences
- Exceeding the speed threshold set for the geofence
- Exceeding the set speed threshold

In the “Output operation mode” section:

Number of “closed-open” cycles – specify the number of output enabling/disabling.

Possible options:

- continuous – the output is always enabled (only available for states)

Auxiliary Equipment

- from 1 to 9 – (only relevant for events, because for states fulfillment of this condition would lead to indefinite cycles repeating)

When selecting the number of cycles, specify:

“Delay before closing” – specify the time period until the output will be activated. Possible values: from 0.1 to 9.9 s.

“Duration of closing” – specify the time, during which the output must be activated. Possible values: from 0.1 to 9.9 s.

“Duration of opening” – specify the time until the next output activation. Possible values: from 0.0 to 29.9 s.

Example 1. The following values are set:

- State – “Being in geofence”
- Number of “closed-open” cycles – 5

If the vehicle is inside the geofence, the output will be enabled and disabled 5 times. Output enabling/disabling (5 times each) will be repeated until the vehicle exits the geofence.

Example 2. The following values are set:

- State – “Being outside geofence”, “GPS available”
- Number of “closed-open” cycles – “Continuous”

If the vehicle is outside the geofence and the GPS module data are valid, the output will be enabled, until the moment of entering the geofence or GPS data absence.

Connect auxiliary equipment to controlled outputs of Omnicomm Light terminals according to the diagram:

Auxiliary Equipment

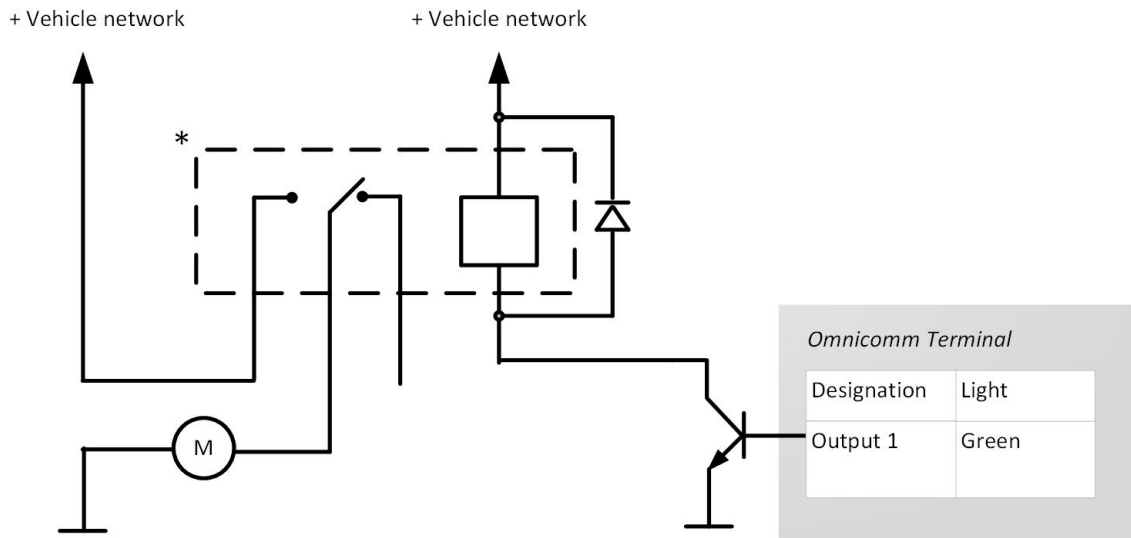

* Relay with operation voltage suitable for the voltage of this vehicle network (12 or 24 VDC)

You can also control digital output by SMS commands: *SETDOUT param#, *GETDOUT#, *CLRDOOUT param#

Geofence Setting for Light

In the terminals, geofences setting is provided to enable the controlled outputs.

In the **"Settings"** tab select the **"Geofences"** section from the list.

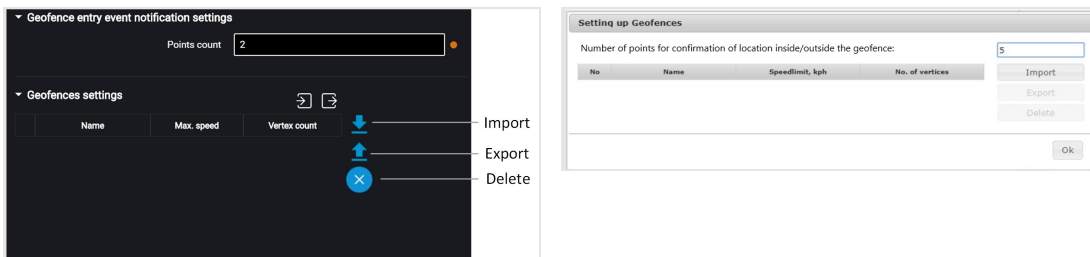

"Number of points to confirm being inside/outside the geofence" – specify the number of successively defined vehicle coordinates required to register the vehicle being inside or outside the geofence. Coordinates determination period – 1 sec. Possible values: from 1 to 10.

To add a geofence, press the "Import" button and select the .xml file with geofence settings.

Auxiliary Equipment

The geofence name must be not more than 8-character long and consist of symbols, digits and Latin letters.

Geofence should not contain consecutive points with the same coordinates.

Maximum number of geofences – 60.

Maximum number of peaks – 240.

Panic button

In the **“Settings”** tab select the **“Auxiliary equipment”** section from the list.

In the **“Panic button parameters”** section:

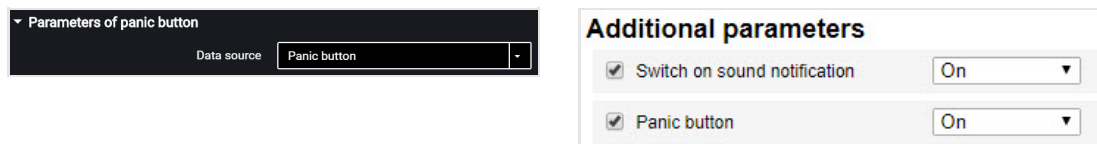

“Data source” – enable/disable condition control of the panic button.

“Send SMS upon triggering” – enable/disable SMS sending upon the panic button pressing.

Connect the panic button according to the diagram:

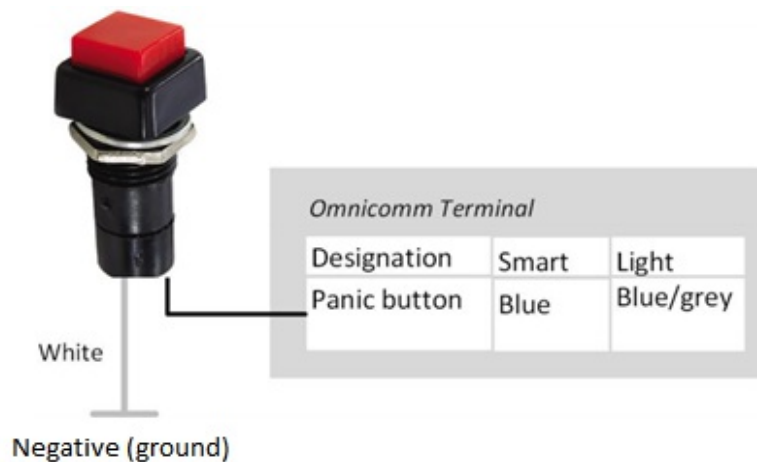

Auxiliary Equipment

CAN Bus

In the “Settings” tab select the “CAN” section from the list:

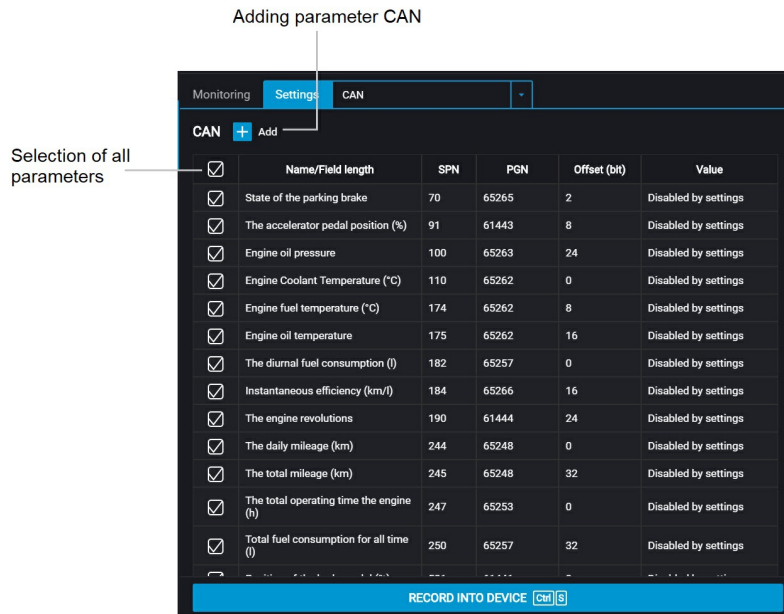

CAN parameters

<input checked="" type="checkbox"/> Parking brake status	Off
<input checked="" type="checkbox"/> Accelerator pedal position	Off
<input checked="" type="checkbox"/> Engine oil pressure	Off
<input checked="" type="checkbox"/> Engine coolant temperature	Off
<input checked="" type="checkbox"/> Fuel temperature	Off
<input checked="" type="checkbox"/> Engine oil temperature	Off
<input checked="" type="checkbox"/> Daily fuel consumption	Off
<input checked="" type="checkbox"/> Instantaneous fuel economy	Off
<input checked="" type="checkbox"/> Engine RPM	Off
<input checked="" type="checkbox"/> Daily mileage	Off

From the list, select the parameters, which value shall be displayed in Omnicomm Online, and check the corresponding boxes in the column “Use”.

If you need to add parameters for reading from the CAN bus, which are not on the list, in Omnicomm Configurator press button “Add”. A window will open:

Auxiliary Equipment

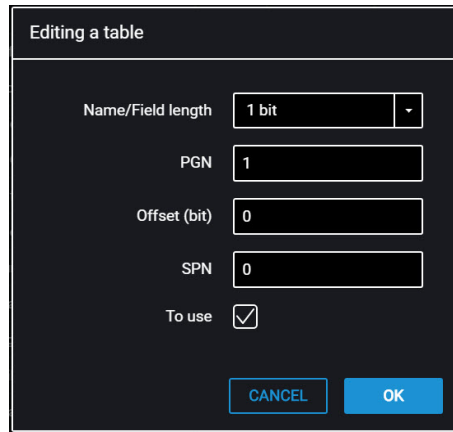

Editing a table

Name/Field length: 1 bit

PGN: 1

Offset (bit): 0

SPN: 0

To use:

CANCEL OK

“Length” – select the length of the data packet. Possible values: 1, 2, 3, 4 (bit), 1, 2, 4 (bytes).

“PGN” – enter the parameter group number that defines the contents of the corresponding message according to SAE J1939. Possible values: from 1 to 262143.

“Offset” – enter the offset value relative to the base address of the bit storing area. Possible values: from 0 to 63.

“SPN” – enter the parameter code according to SAE J1939. Possible values: from 0 to 4294967295.

“To use” – check the box if you want to read this parameter from the CAN bus.

Press the “Save” button.

Perform connection to the vehicle CAN bus using wireless CAN reader device (CAN-crocodile).

When using wireless CAN reader devices, connect the terminals according to the diagram:

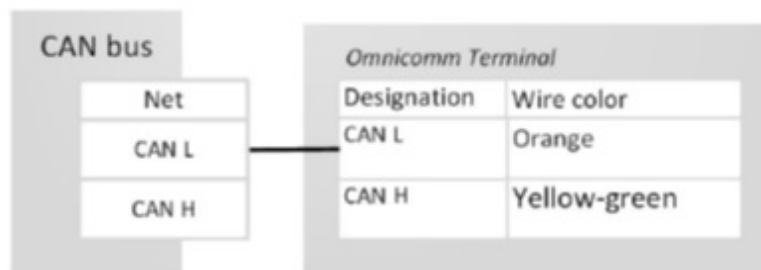

Configuring the reception of data on the fuel volume in the tank from the vehicle CAN bus Connect and configure reception of the vehicle equipment operation parameters from CAN J1939 data bus and set the setting of fuel sensor – “CAN Sensor”.

Check indication of the fuel sensor values in the “Monitoring” tab, the value must be from 0 to 4095.

Auxiliary Equipment

When reading the fuel level in the tank from the CAN bus, set the operating mode of the terminal while ignition off to "Collect data during pounding" mode. Otherwise, the fuel level graphic will not be displayed correctly.

LED Notification

LED Notification

Indicator	Indication mode	Value
Power red/orange/green	Off	Power: absent OR 2 minutes have passed since the ignition was turned on
	Alternately flashes red-green	Off Power: Main Ignition: Off Operating Mode: "Collect all data except GPS"
	Flashing red at interval 4 times per second	Power: from USB (if there is charger backup battery)
	Permanently lighted green	Power: Main Ignition: On
	Flashing orange	Within the GSM network coverage, available data exchange with communication server through GPRS channel
	Flashing red once per second	Power: Main or backup battery (if any) Ignition: Off Operating mode: "Sleeping"
GPS red/green	Off	Module power supply off OR 2 minutes have passed since the ignition was turned on

SMS Commands

Indicator	Indication mode	Value
	Alternately flashes red/green	In case of module failure, the indicator "Accident" is lighted
	Permanently lighted green	Valid data from satellites are recieved
	Permanently lighted red	No data reception from satellites or invalis data recieved
Power and GPS	Flashing red simultaneously at 1-second intervals	Power: main or backup battery (if available). Terminal is locked. Contact your dealer

SMS Commands

SMS commands for terminal management

Command		Designation
Command text in SMS	Reply to a command in SMS	
*SOUND 1#	SOUND ON	Request for turning on the siren
*SOUND 0#	SOUND OFF	Request for turning off the siren

SMS Commands

Command		Designation
Command text in SMS	Reply to a command in SMS	
*SETDOUT param# Param=0 Param=1 Param=0,1	SETDOUT Possible parameter values: param = OK if the command is forwarded to execution param = ER if the command is not forwarded to execution	Request for enabling digital output
*GETIMG#	GETIMG param Possible parameter values: param = OK if the command is forwarded to execution param = ER if the command is not forwarded to execution	Request for taking picture (if the camera is connected)
*CLRDOOUT param# Param=0 Param=1 Param=0,1	CRLDOOUT param Possible parameter values: param = OK if the command is forwarded to execution param = ER if the command is not forwarded to execution	Request for enabling digital output
*GETDOUT#	DOUT 0=1 1=0 где: output_number=output_state	Request for state of digital output
*CONNECT#	CONNECT address_CS:port	Request for establishing connection of Terminal with CS
*GETLINK#	LINK ip4_CS_address:port date_and_time	Request for status of connection to CS

SMS Commands

Command		Designation
Command text in SMS	Reply to a command in SMS	
*GETINFO#	INFO DID=deviceID HW=hardware_code_version BL=bootloader_version FW=firmware_version REC=number_of_records_in_archive IMEI=GSM_modem_unique_identifier	Request for state of terminal
*RESET#	RESET param Possible parameter values: param = OK if the command is forwarded to execution param = ER if the command is not forwarded to execution	Reset of terminal
*GETSTAT#	STAT terminal_date_and_time GPS=position as per GPS SPD=speed IGN=ignition_state L1=fuel_level:sensor_state L6=fuel_level:sensor_state Fuel level sensor state codes LLS/LLS-AF: • 0 - disabled; • 1 - not ready; • 2 - ready, , frequency 20 - max Hz; • 3 - error, frequency 0 - 19 Hz;	Request for vehicle state
*SETPWDID vid pwwid# vid - identification of Terminal; pwwid - password/identification.	SETPWDID ERRID/ERRNuIPWD/ERRAIrSet/PWD:pwwid OK	Setting parameter "Password"

SMS Commands

Command		Designation
Command text in SMS	Reply to a command in SMS	

*CONNECTSC#	CONNECT SC	Request for connection of terminal with configurator server
*SETAPN apn# apn - APN of the operator	SETAPN apn ERR/OK	Setting APN
*GPSCOLD#	GPSCOLD ERR/OK	Cold start of GPS receiver
*UNBLOCK#		Unblocking the terminal
*SGPSINFO#	Smooth position type: N, VID=xxxxxxxx N = 0/1/2 0 – smoothing disabled 1 – smoothing enabled, filter 1 in use 2 – smoothing enabled, filter 2 in use VID – terminal ID	Request information about the current status of the coordinate filtering algorithm
*SGPS0#	OFF smooth position, VID=xxxxxxxx	Disable smoothing algorithm

SMS Commands

Command		Designation
Command text in SMS	Reply to a command in SMS	
*SGPS1#	ON smooth position method 1, VID=xxxxxxxxxx	Enable smoothing (filter 1)
*GETCNTINFO#	GETCNTINFO LLS1: CNTmin1, CNTmax1, CNT_T LLS2:VID = 336xxxxxxxx	Request current CNT readings
*SETCNT pwd numlls CNTmin2 CNTmax2#	SETCNT OK – SMS worked correctly SETCNT PWD ERR – wrong or no password entered (see Limitations) SETCNT ERRVALUE – the entered CNT values do not comply with the Limits SETCNT ERRPARAM – incorrect SMS format	Set new CNT_empty/full values (CNTmin2 and CNTmax2)
*SETCNTFULL pwd numlls koef_empty#	SETCNTFULL OK – SMS worked correctly SETCNT PWD ERR – wrong or no password entered (see Limitations) SETCNTFULL ERRVALUE – Conditions outlined in the Limitations were not met SETCNT ERRPARAM – wrong SMS format	Automatic correction of the CNT_empty/full values

SMS Commands

Command		Designation
Command text in SMS	Reply to a command in SMS	
*SETCANSPD X# X – data rate of CAN 0 - 250 kb/s 1 - 125 kb/s 2 - 250 kb/s 3 - 500 kb/s 4 - 1 Mb/s 5 - 50 kb/s 6 - 62,5 kb/s	SETCANSPD OK – SMS worked correctly	Set data rate of CAN- interface (starting from FW-311) Default value - 250 kb/s
*GETCANSPD#	can speed = X X – data rate value CAN 0 - 250 kb/s 1 - 125 kb/s 2 - 250 kb/s 3 - 500 kb/s 4 - 1 Mb/s 5 - 50 kb/s 6 - 62,5 kb/s CAN SPEED = ER - incorrect value of data rate (default value - 250 kb/s)	CAN interface data rate request (starting from FW-311)

For the command Automatic correction of the CNT_empty/full values:

Recalculation formula:

$$\text{CNTmin2} = \text{CNTmin1} + \text{koef_empty} * (|\text{CNTmax1} - \text{CNT_T}|)$$

$$\text{CNTmax2} = \text{CNT_T}$$

If koef_empty = 0, then CNT_empty does not change (CNTmin2=CNTmin1)

If koef_empty = 1, then CNT_empty increases by the same Δ as CNT_full

CNT_full (CNTmax2) is assigned the value of the current CNT_T level

SMS from the Terminal

Event	Message format	Example
Panic button triggering	Panic button. Vehicle name; VID; http://google.com/maps?q=Latitude, Longitude; dd/mm/yyyy; hh:ss .	Panic button. E777KX_97; ID336011133; http://google.com/maps?q=55.7889,37.5887 ; 01/04/19; 09:25.
Dangerous driving is detected	Dangerous driving. a=xx.xx g on the X-axis; Vehicle name; VID; http://google.com/maps?q=Latitude, Longitude; dd/mm/yyyy; hh:ss .	Dangerous driving. Suspension impact>0.20 g, E777KX_97; ID336011133; http://google.com/maps?q=55.7887,37.5887 ; 01/04/19; 09:29. Dangerous driving. Sharp turn>0.20 g, E777KX_97; ID336011133; http://google.com/maps?q=55.7887,37.5887 ; 01/04/19; 09:29. Dangerous driving. Acceleration>0.20 g, E777KX_97; ID336011133; http://google.com/maps?q=55.7886,37.5887 ; 01/04/19; 09:33. Dangerous driving. Braking>0.20 g, Suspension impact>0.20 g, E777KX_97; ID336011133; http://google.com/maps?q=55.7886,37.5889 ; 01/04/19; 09:40.
An accident is detected	Accident. a=xx.xx g on the X-axis; Vehicle name; VID; http://google.com/maps?q=Latitude, Longitude; dd/mm/yyyy; hh:ss .	Accident. a>0.40 g; E777KX_97; ID336011133; http://google.com/maps?q=55.7887,37.5891 ; 01/04/19; 09:45.

Firmware Change Log

Event	Message format	Example
Universal input triggering	Sensor. Equipment name. UI. Vehicle name; VID; http://google.com/maps?q=Latitude , Longitude; dd/mm/yyyy; hh:ss.	Uni 1 sensor. E777KX_97; ID336011133; http://google.com/maps?q=55.7887,37.5888 ; 01/04/19; 09:29.
Body tampering	Body tampering. Vehicle name; VID; http://google.com/maps?q=Latitude , Longitude; dd/mm/yyyy; hh:ss.	Body tampering. E777KX_97; ID336011133; http://google.com/maps?q=55.7886,37.5888 ; 01/04/19; 09:36.
Overspeeding	Speed. Speed value>Value of the speed threshold; km/h; Vehicle name; VID; http://google.com/maps?q=Latitude , Longitude; dd/mm/yyyy; hh,ss	Speed. 88>60 km/h; E777KX_97; ID336011133; http://google.com/maps?q=55.7886,37.5888 ; 01/04/19; 09:36.
Exceeding of RPM	RPM. RPM value>Value of RPM threshold, rpm; Vehicle name; VID; http://google.com/maps?q=Latitude , Longitude; dd/mm/yyyy; hh:ss	RPM. 42000>20000 rpm; E777KX_97; ID336011133; http://google.com/maps?q=55.7886,37.5888 ; 01/04/19; 09:36.

Firmware Change Log

Date	Firmware Version	Changes
July 26, 2018	FW 305	<ul style="list-style-type: none"> - upgraded GPS connection (satellite loss, track gaps solved) - failure after page reloading rectified - track gaps in case of CS failure eliminated

Firmware Change Log

Date	Firmware Version	Changes
January 14, 2019	FW 307	<ul style="list-style-type: none"> - solved factory reset issue when cleaning the terminal data archive or in case of on-board network voltage drop - enhanced GPS communication (eliminated periodic coordinate discarding at 00-00 UTC) - solved a problem of lack of communication with Profi Wi-Fi terminals, if there is a 0 in IP-address (for example, 192.168.0.1) - rectified freezing of OmnicommLLS-AF fuel level sensor values when the terminal switches to Collect all except GPS mode
March 20, 2019	FW 308	<ul style="list-style-type: none"> - implemented the function of collecting arbitrary CAN-parameters from VH operating according to FMS, and displaying CAN data in Omnicomm Online - terminal factory reset eliminated - solved failures of terminal time stamps, VID, PID - added protection from satellite loss due to QZSS (Japanese Quasi-Zenith Satellite System) - implemented the function of the terminal calling back to the number in case of bad voice connection

Firmware Change Log

Date	Firmware Version	Changes
October 31, 2019	FW 309	<ul style="list-style-type: none"> - a new speed filtration algorithm when selecting GPS data source developed - it is now possible to transfer data to 3 Communication Servers simultaneously - a possible period of data collection has been decreased to one time per 1 second - now up to 2 digital LLS fuel level sensors can be connected to Smart terminals, and up to 4 digital sensors – to Light - GSM signal level is displayed now - ContiPressureCheck tyre pressure monitoring system now supported - accelerometer calibration state is now displayed at the Remote Configuration Server - the number of geofences has been increased to 60, and the number of peaks to 240
March 5, 2021	FW 311	<ul style="list-style-type: none"> - remote configuration and firmware of Omnicomm LLS 5 and LLS-Ex 5 fuel level sensors provided - SMS command to set the speed value for CAN bus operation is added - Omnicomm OKO Light video recorder is supported

OMNICOMM

info@omnicomm-world.com

www.omnicomm-world.com